

DE	Montageanleitung	2
FR	Instructions de montage	2
EN	assembly instructions	3
IT	Istruzioni per Installazione	3
ES	Instrucciones de montaje	4
NL	Handleiding	4
DK	Monteringsvejledning	5
PT	Manual de Instalação	5
PL	Instrukcja montażu	6
CS	Montážní návod	6
SK	Montážny návod	7
ZH	组装说明	7
RU	Инструкция по монтажу	8
HU	Szerelési útmutató	8
FI	Asennusohje	9
SV	Monteringsanvisning	9
LT	Montavimo instrukcijos	10
HR	Uputstva za instalaciju	10
TR	Montaj kılavuzu	11
RO	Instrucțiuni de montare	11
EL	Οδηγία συναρμολόγησης	12
SL	Navodila za montažo	12
ET	Paigaldusjuhend	13
LV	Montāžas instrukcija	13
SR	Uputstvo za montažu	14
NO	Montasjeveiledning	14
BG	Ръководство за монтаж	15
SQ	Udhëzime rreth montimit	15
AR	تعليمات التجميع	16

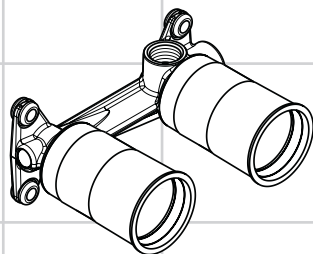

13622180



Sicherheitshinweise

- △ Bei der Montage müssen zur Vermeidung von Quetsch- und Schnittverletzungen Handschuhe getragen werden.
- △ Große Druckunterschiede zwischen den Kalt- und Warmwasseranschlüssen müssen ausgeglichen werden.

Montagehinweise

- Vor der Montage muss das Produkt auf Transportschäden untersucht werden. Nach dem Einbau werden keine Transport- oder Oberflächenschäden anerkannt.
- Die Leitungen und die Armatur müssen nach den gültigen Normen montiert, gespült und geprüft werden.
- Die in den Ländern jeweils gültigen Installationsrichtlinien sind einzuhalten.

Symbolerklärung



Kein essigsäurehaltiges Silikon verwenden!



Fertigset (siehe Seite 18)



Maße (siehe Seite 42)



Serviceteile (siehe Seite 42)



Prüfzeichen (siehe Seite 42)

Consignes de sécurité

- △ Lors du montage, porter des gants de protection pour éviter toute blessure par écrasement ou coupure.
- △ Il est conseillé d'équilibrer les pressions de l'eau chaude et froide.

Instructions pour le montage

- Avant son montage, s'assurer que le produit n'a subi aucun dommage pendant le transport. Après le montage, tout dommage de transport ou de surface ne pourra pas être reconnu.
- Les conduites et la robinetterie doivent être montés, rincés et contrôlés selon les normes en vigueur.
- Les directives d'installation en vigueur dans le pays concerné doivent être respectées.

Description du symbole



Ne pas utiliser de silicone contenant de l'acide acétique!



Set de finition (voir pages 18)



Dimensions (voir pages 42)



Pièces détachées (voir pages 42)





Classification acoustique et débit (voir pages 42)





Safety Notes

-  Gloves should be worn during installation to prevent crushing and cutting injuries.
-  The hot and cold supplies must be of equal pressures.

Installation Instructions

- Prior to installation, inspect the product for transport damages. After it has been installed, no transport or surface damage will be honoured.
- The pipes and the fixture must be installed, flushed and tested as per the applicable standards.
- The plumbing codes applicable in the respective countries must be observed.

Symbol description



Do not use silicone containing acetic acid!



Finish set (see page 18)



Dimensions (see page 42)





Spare parts (see page 42)



Test certificate (see page 42)

Indicazioni sulla sicurezza

-  Durante il montaggio, per evitare ferite da schiacciamento e da taglio bisogna indossare guanti protettivi.
-  Attenzione! Compensare le differenze di pressione tra i collegamenti dell'acqua fredda e dell'acqua calda.

Istruzioni per il montaggio

- Prima del montaggio è necessario controllare che non ci siano stati danni durante il trasporto. Una volta eseguito il montaggio, non verranno riconosciuti eventuali danni di trasporto o delle superfici.
- Montare, lavare e controllare tubature e rubinetteria rispettando le norme correnti.
- Vanno rispettate le direttive di installazione nazionali vigenti nel rispettivo paese.

Descrizione simbolo



Non utilizzare silicone contenente acido acetico!



Set esterno (vedi pagg. 18)



Ingombri (vedi pagg. 42)



Parti di ricambio (vedi pagg. 42)



Segno di verifica (vedi pagg. 42)

Assembly
see page 17



Montaggio
vedi pagg. 17



Indicaciones de seguridad

- △ Durante el montaje deben utilizarse guantes para evitar heridas por aplastamiento o corte.
- △ Grandes diferencias de presión en servicio entre agua fría y agua caliente deben equilibrarse.

Indicaciones para el montaje

- Antes del montaje se debe examinarse el producto contra daños de transporte. Después de la instalación no se reconoce ningún daño de transporte o de superficie.
- Los conductos y la grifería deben montarse, lavarse y comprobarse según las normas vigentes.
- Es obligatorio el cumplimiento de las directrices de instalación vigentes en el país respectivo.

Descripción de símbolos



No utilizar silicona que contiene ácido acético!



Embellecedor exterior
(ver página 18)



Dimensiones (ver página 42)



Repuestos (ver página 42)



Marca de verificación
(ver página 42)

Veiligheidsinstructies

- △ Bij de montage moeten ter voorkoming van knel- en snijwonden handschoenen worden gedragen.
- △ Grote drukverschillen tussen de koud- en warmwatertoevoer dienen vermeden te worden.

Montage-instructies

- Vóór de montage moet het product gecontroleerd worden op transportschade. Na de inbouw wordt geen transport- of oppervlakteschade meer aanvaard.
- De leidingen en armaturen moeten gemonteerd, gespoeeld en gecontroleerd worden volgens de geldige normen.
- De in de overeenkomstige landen geldende installatie-richtlijnen moeten nageleefd worden.

Symbolbeschrijving



Gebruik geen zuurhoudende silicone!



Kleurset (zie blz. 18)



Maten (zie blz. 42)



Service onderdelen (zie blz. 42)



Keurmerk (zie blz. 42)





Sikkerhedsanvisninger

- △ Ved monteringen skal der bruges handsker for at undgå kvæstelser og snitsår.
- △ Større trykforskelle mellem koldt og varmt vand bør udjævnes.

Monteringsanvisninger

- Før monteringen skal produktet kontrolleres for transportskader. Efter monteringen godkendes transportskader eller skader på overfladen ikke længere.
- Ledningerne og armaturerne skal monteres, skylles og kontrolleres iht. de gældende standarder.
- Installationsbestemmelserne, der gælder i det enkelte land, skal overholdes.

Symbolbeskrivelse



Der må ikke benyttes eddikesyreholdig silikone!



Kappesæt (se s. 18)



Målene (se s. 42)



Reservedele (se s. 42)



Godkendelse (se s. 42)

Avisos de segurança

- △ Durante a montagem devem ser utilizadas luvas de protecção, de modo a evitar ferimentos resultantes de entalamentos e de cortes.
- △ Grandes diferenças entre as pressões das águas quente e fria devem ser compensadas.

Avisos de montagem

- Antes da montagem deve-se controlar o produto relativamente a danos de transporte. Após a montagem não são aceites quaisquer danos de transporte ou de superfície.
- As tubagens e a torneira têm que ser montadas, enxaguadas e verificadas de acordo com as normas em vigor.
- A prescrições de instalação válidas nos respetivos países devem ser respeitadas.

Descrição do símbolo



Não utilizar silicone que contenha ácido acético!



Conjunto completo
(ver página 18)



Medidas (ver página 42)



Peças de substituição
(ver página 42)



Marca de controlo
(ver página 42)





Wskazówki bezpieczeństwa

- △ Aby uniknąć zranień na skutek zgniecenia lub przecięcia, podczas montażu należy nosić rękawice ochronne.
- △ Znaczne różnice ciśnień na doptywach ciepłej i zimnej wody muszą zostać wyrównane.

Wskazówki montażowe

- Przed montażem należy skontrolować produkt pod kątem szkód transportowych. Po montażu nie widać żadnych szkód transportowych ani szkód na powierzchni.
- Przewody i armatura muszą być montowane, płukane i kontrolowane według obowiązujących norm.
- Należy przestrzegać wytycznych instalacyjnych obowiązujących w danym kraju.

Opis symbolu



Nie stosować silikonów zawierających kwas octowy!



Elementy zewnętrzne
(patrz strona 18)



Wymiary (patrz strona 42)



Części serwisowe
(patrz strona 42)



Znak jakości (patrz strona 42)

Bezpečnostní pokyny

- △ Pro zabránění řezným zraněním a pohmožděním je nutné při montáži nosit rukavice.
- △ Je nutné vyrovnat velké rozdíly tlaku mezi přípoji studené a teplé vody.

Pokyny k montáži

- Před montáží je třeba produkt zkontrolovat, zda nebyl při transportu poškozen. Po zabudování nebudou uznány žádné škody způsobené transportem nebo poškození povrchu.
- Vedení a armatura musí být namontovány, propláchnuty a otestovány podle platných norem.
- Je třeba dodržovat montážní pravidla platné v dané zemi.

Popis symbolů



Nepoužívat silikon s obsahem kyseliny octové!



Vrchní sada (viz strana 18)



Rozměry (viz strana 42)



Servisní díly (viz strana 42)



Zkušební značka (viz strana 42)





Bezpečnostné pokyny

- △ Pri montáži musíte nosiť rukavice, aby ste predišli pomliaždeninám a rezným poraneniam.
- △ Velké rozdiely v tlaku medzi prípojkami studenej a teplej vody musia byť vyrovnané.

Pokyny pre montáž

- Pred montážou musíte produkt skontrolovať, či nebol počas transportu poškodený. Po zabudovaní nebudú uznané žiadne škody spôsobené transportom alebo poškodenia povrchu.
- Ledningarna och blandaren måste monteras, spolás igenom och kontrolleras enligt de gällande normerna.
- Je potrebné dodržiavať smernice o inštalácii, ktoré sú práve teraz platné v krajinách.

Popis symbolov



Nepoužívať silikón s obsahom kyseliny octovej!



Vrchná sada (viď strana 18)



Rozmery (viď strana 42)



Servisné diely (viď strana 42)



Osvedčenie o skúške
(viď strana 42)

安全技巧

- △ 装配时为避免挤压和切割受伤，必须戴上手套。
- △ 冷热水管间过大的压力差必须予以平衡。

安装提示

- 安装前必须检查产品是否受到运输损害。安装后将不认可运输损害或表面损伤。
- 管道和阀门必须根据通用标准进行安装、冲洗和检查。
- 请遵守当地国家现行的安装规定。

符号说明



请勿使用含有乙酸的硅胶！



加工件 (参见第页 18)



大小 (参见第页 42)



备用零件 (参见第页 42)





检验标记 (参见第页 42)





Указания по технике безопасности

-  Во время монтажа следует надеть перчатки во избежание прищемления и порезов.
-  донного клапа. Перед установкой смесителя необходимо регулировочными кранами выровнять авление холодной и горячей воды при помощи вентилей регулирующих подачу воды в квартиру.

Указания по монтажу

- Перед монтажом следует проверить изделие на предмет повреждений при перевозке. После монтажа претензии о возмещении ущерба за повреждения при перевозке или повреждения поверхностей не принимаются.
- Трубы и арматура должны быть установлены, промыты и проверены в соответствии с действующими нормами.
- Необходимо соблюдать требования по монтажу, действующие в соответствующих странах.

Описание символов



Не применяйте силикон, содержащий уксусную кислоту.



Наружная часть (см. стр. 18)



Размеры (см. стр. 42)





Комплект (см. стр. 42)



Знак технического контроля
(см. стр. 42)

Biztonsági utasítások

-  A szerelésnél a zúzódások és vágási sérülések elkerülése érdekében kesztyűt kell viselni.
-  A hidegvíz- és a melegvíz-csatlakozások közötti nagy nyomáskülönbséget kikell egyenlíteni!

Szerelési utasítások

- A szerelés előtt ellenőrizni kell, hogy a terméknek nincs-e szállítási sérülése. Beépítés után a szállítási- vagy felületi sérüléseket nem ismerik el.
- A vezetékeket és a csaptelepét az érvényes szabványoknak megfelelően kell felszerelni, öblíteni és ellenőrizni
- Az egyes országokban érvényes installációs irányelveket be kell tartani.

Szimbólumok leírása



Ne használjon ecetsavtartalmú szilikont!



A kész szerelvény
(lásd a oldalon 18)



Méretet (lásd a oldalon 42)



Tartozékok (lásd a oldalon 42)



Vizsgajel (lásd a oldalon 42)





Turvallisuusohjeet

- △ Asennuksessa on käytettävä käsiineitä puristumien ja viiltojen aiheuttamien tapaturmien estämiseksi.
- △ Suuret paine-erot kylmä- ja kuumavesiliitäntöjen välillä on tasattava.

Asennusohjeet

- Ennen asennusta on tarkastettava tuotteen mahdolliset kuljetusvahingot. Asennuksen jälkeen kuljetus- ja pintavaurioita ei hyväksytä.
- Putket ja hana on asennettava, huuhdeltava ja tarkastettava voimassa olevien standardien mukaisesti.
- Jokaisessa maassa on noudatettava siellä päteviä asennusohjeita.

Merkin kuvaus



Älä käytä etikahappopitoista silikoniala!



Valmissarja (katso sivu 18)



Mitat (katso sivu 42)



Varaosat (katso sivu 42)



Koestusmerkki (katso sivu 42)

Säkerhetsanvisningar

- △ Handskar ska bäras under monteringsarbetet så att man kan undvika kläm- och skärskadorgen werden.
- △ Stora tryckskillnader mellan anslutningarna för varmt och kallt vatten måste utjämnas.

Monteringsanvisningar

- Det måste undersökas om produkten har transportskador innan den monteras. Efter monteringen accepteras inga transport- eller ytskiktsskador.
- Ledningarna och blandaren måste monteras, spolas igenom och kontrolleras enligt de gällande normerna.
- De installationsriktlinjer som gäller i länderna ska följas.

Symbolförklaring



Använd inte silikon som innehåller ättiksyra!



Färdigset (se sidan 18)



Måtten (se sidan 42)



Reservdelar (se sidan 42)



Testsigill (se sidan 42)





Saugumo technikos nurodymai

- ⚠ Apsaugai nuo užspaudimo ir įsijovimo montavimo metu mūvėkite pirštines.
- ⚠ Turi būti išlyginti šalto ir karšto slėgio nelygumai.

Montavimo instrukcija

- Prieš montuojant būtina patikrinti, ar gaminys nebuvo pažeistas transportavimo metu. Sumontavus pretenzijos dėl transportavimo ir paviršiaus pažeidimų nepriimamos.
- Vamzdžiai ir sujungimai turi būti montuojami, plaunami ir tikrinami pagal galiojančias normas.
- Laikytės atitinkamoje šalyje galiojančių direktyvų dėl įrengimo.

Sigurnosne upute

- ⚠ Prilikom montaže se radi sprječavanja prignječenja i posjekotina moraju nositi rukavice.
- ⚠ Velika razlika u pritisku između vruće i hladne vode mora biti izbalansirana.

Upute za montažu

- Prije montaže mora se provjeriti je li proizvod oštećen prilikom transporta. Nakon ugradnje se ne priznaju nikakve reklamacije koje se odnose na površinska i transportna oštećenja.
- Cijevi i armatura moraju biti postavljeni, isprani i testirani prema važećim normama.
- Obvezno se moraju uvažiti propisi o instalacijama koji vrijede u dotičnoj zemlji.

Simbolio aprašymas



Nenaudokite silikono, kurio sudėtyje yra acto rūgšties!



Virštinkinė (žr. psl. 18)



Išmatavimai (žr. psl. 42)



Atsarginės dalys (žr. psl. 42)



Bandymo pažyma (žr. psl. 42)

Opis simbola



Nemojte koristiti silikon koji sadrži octenu kiselinu!



Završni set (pogledaj stranicu 18)



Mjere (pogledaj stranicu 42)



Rezervni djelovi
(pogledaj stranicu 42)



Oznaka testiranja
(pogledaj stranicu 42)





⚠ Güvenlik uyarıları

- ⚠ Montaj esnasında ezilme ve kesilme gibi yaralanmaları önlemek için eldiven kullanılmalıdır.
- ⚠ Sıcak ve soğuk su bağlantıları arasında büyük basınç farklılıkları varsa, bu basınç farklılıklarının dengelenmesi gerekir.

Montaj açıklamaları

- Montaj işleminden önce ürün nakliye hasarları yönünden kontrol edilmelidir. Montaj işleminden sonra nakliye veya yüzey hasarları için sorumluluk üstlenilmemektedir.
- Boruların ve armatürün montajı, yıkanması ve kontrolü geçerli normlara göre yapılmalıdır.
- Ülkelerde geçerli kurulum yönetmeliklerine riayet edilmelidir.

⚠ Instrucțiuni de siguranță

- ⚠ La montare utilizați mănuși pentru evitarea contuziunilor și tăierii mâinilor.
- ⚠ Diferențele de presiune mari între alimentarea cu apă rece și apă caldă trebuie echilibrate.

Instrucțiuni de montare

- Înainte de instalare verificați, dacă produsul prezintă deteriorări de transport. După instalare garanția nu acoperă deteriorările de transport și cele de suprafață.
- Conductele și bateriile trebuie montate, spălate și verificate conform normelor în vigoare.
- Respectați reglementările referitoare la instalare valabile în țara respectivă.

Simge açıklaması



Asetik asit içeren silikon kullanmayın!



Dışı set (bakınız sayfa 18)



Ölçüleri (bakınız sayfa 42)



Yedek Parçalar (bakınız sayfa 42)



Kontrol işareti (bakınız sayfa 42)

Descrierea simbolurilor



Nu utilizați silicon cu conținut de acid acetic!



Set complet (vezi pag. 18)



Dimensiuni (vezi pag. 42)



Piese de schimb (vezi pag. 42)



Certificat de testare
(vezi pag. 42)

**Montajı
bakınız sayfa 17**



**Montare
vezi pag. 17**

**⚠ Υποδειξεις ασφαλείας**

- ⚠ Για να αποφύγετε τραυματισμούς κατά τη συναρμολόγηση πρέπει να φοράτε γάντια.
- ⚠ Οι διαφορές της πίεσης μεταξύ της σύνδεσης κρύου και ζεστού νερού θα πρέπει να αντισταθμίζονται.

Οδηγίες συναρμολόγησης

- Πριν τη συναρμολόγηση πρέπει να εξεταστεί το προϊόν για ζημιές μεταφοράς. Μετά την εγκατάσταση δεν αναγνωρίζονται ζημιές από τη μεταφορά ή επιφανειακές ζημιές.
- Οι σωλήνες και η μπαταρία πρέπει να τοποθετηθούν σύμφωνα με τα ισχύοντα πρότυπα, να τεθούν υπό πίεση και να δοκιμαστούν.
- Θα πρέπει να τηρούνται οι οδηγίες εγκατάστασης που ισχύουν σε κάθε κράτος.

Περιγραφή συμβόλων

Μην χρησιμοποιείτε σιλικόνη που περιέχει οξικό οξύ!



Σετ μηχανισμού (βλ. Σελίδα 18)



Διαστάσεις (βλ. Σελίδα 42)



Ανταλλακτικά (βλ. Σελίδα 42)



Σήμα ελέγχου (βλ. Σελίδα 42)

⚠ Varnostna opozorila

- ⚠ Pri montaži je treba nositi rokavice, da se preprečijo poškodbe zaradi zmečkanja ali urezov.
- ⚠ Velike razlike v tlaku med priključkom za mrzlo in priključkom za toplo vodo je potrebno izravnati.

Navodila za montažo

- Pred montažo je treba izdelek preveriti glede morebitnih transportnih poškodb. Po vgradnji transportne ali površinske poškodbe ne bodo več priznane.
- Cevi in armaturo je treba montirati, izprati in preveriti po veljavnih standardih.
- Uproštevati je treba pravilnike o inštalacijah, ki veljajo v posamezni državi.

Opis simbola

Ne smete uporabiti silikona, ki vsebuje ocetno kislino!



Zaključna garnitura
(glejte stran 18)



Mere (glejte stran 42)



Rezervni deli (glejte stran 42)



Preskusni znak (glejte stran 42)





Ohutusjuhised

- △ Kandke paigaldamisel muljumis- ja löikevigastuste vältimiseks kindaid.
- △ Kui külma ja kuuma vee ühenduste surve on väga erinev, tuleb need tasakaalustada.

Paigaldamisjuhised

- Enne paigaldamist tuleb toodet kontrollida transportdikahjustuste osas. Pärast paigaldamist ei tunnustata enam transporti- või pinnakahjustuste kaebuseid.
- Voolikute ja segisti paigaldamisel, loputamisel ja kontrollimisel tuleb lähtuda kehtivatest normatiividest.
- Vastavas riigis kehtivaid paigalduseeskirju tuleb järgida.

Sümbolite kirjeldus



Ärge kasutage äädikhapet sisaldavat silikooni!



Valmiskomplekt (vt lk 18)



Mõõtude (vt lk 42)



Varuosad (vt lk 42)



Kontrollsertifikaat (vt lk 42)

Drošības norādes

- △ Montāžas laikā, lai izvairītos no saspiedumiem un iegriezumiem, nepieciešams nēsāt cimdus.
- △ Jāizlīdzina spiediena atšķirības starp aukstā un karstā ūdens pievadiem.

Norādījumi montāžai

- Pirms montāžas nepieciešams pārbaudīt, vai produktam transportēšanas laikā nav radušies bojājumi. Pēc iebūvēšanas bojājumi, kas radušies transportēšanas laikā, vai virsmas bojājumi netiek atzīti.
- Cauruļvadi un armatūra ir jāuzstāda, jāizskalo un jāpārbauda saskaņā ar spēkā esošajiem standartiem.
- Jāievēro attiecīgās valsts spēkā esošās montāžas prasības.

Simbolu nozīme



Neizmantojiet silikonu, kas satur etiķskābi!



Komplekts (skat. lpp. 18)



Izmērus (skat. lpp. 42)



Rezerves daļas (skat. lpp. 42)



Pārbaudes zīme (skat. lpp. 42)





Sigurnosne napomene

- △ Prilikom montaže se radi sprečavanja prignječenja i posekotina moraju nositi rukavice.
- △ Velika razlika u pritisku između vruće i hladne vode mora biti izbalansirana.

Instrukcije za montažu

- Pre montaže se mora proveriti da li je proizvod oštećen pri transportu. Nakon ugradnje se ne priznaju nikakve reklamacije koje se odnose na površinska i transportna oštećenja.
- Vodovi i armatura moraju biti postavljeni, isprani i testirani prema važećim normama.
- Treba se pridržavati propisa koji u određenim zemljama važe za instalacije.

Opis simbola



Nemojte koristiti silikon koji sadrži sircetnu kiselinu!



Završni set (vidi stranu 18)



Mere (vidi stranu 42)



Rezervni delovi (vidi stranu 42)



Ispitni znak (vidi stranu 42)

Sikkerhetshenvisninger

- △ Bruk hansker under montasjen for å unngå klem- og kuttskader.
- △ Store trykkdifferanser mellom kaldt- og varmtvannstilkoblinger skal utlignes.

Montagehenvisninger

- Før montasjen skal produktet sjekkes for transportskader. Etter monteringen aksepteres ikke noen transport- eller overflateskader.
- Ledningene og armaturen skal monteres, spyles og sjekkes iht. de gyldige normer.
- Gjeldende retningslinjer for rørleggerarbeid i de enkelte land skal følges.

Symbolbeskrivelse



Ikke bruk silikon som inneholder eddiksyre!



Ferdigsett (se side 18)



Mål (se side 42)



Serviceleder (se side 42)



Prøvemerk (se side 42)





Указания за безопасност

- △ При монтажа трябва да се носят ръкавици, за да се избегнат наранявания поради притискане или порязване.
- △ Големите разлики в налягането между изводите за студената и топлата вода трябва да се изравняват.

Указания за монтаж

- Преди монтажа продуктът трябва да се провери за транспортни щети. След монтажа не се признават транспортни или повърхностни щети.
- Тръбопроводите и арматурата трябва да се монтират, промият и проверят в съответствие с валидните норми.
- Трябва да бъдат спазвани валидните в съответните страни предписания за инсталиране.

Описание на символите



Не използвайте силикон, съдържащ оцетна киселина!



Готов набор (вижте стр. 18)



Размери (вижте стр. 42)



Сервизни части (вижте стр. 42)



Контролен знак (вижте стр. 42)

Udhëzime sigurie

- △ Për të evituar lëndimet e pickimeve ose të prerjeve gjatë procesit të montimit duhet që të vishni doreza.
- △ Ndryshimet e mëdha të presionit mes lidhjeve të ujit të ftohtë dhe atij të ngrohtë duhen ekuilibruar.

Udhëzime për montimin

- Përpara montimit duhet që produkti të kontrollohet për dëmtime nga transporti. Pas instalimit nuk do të njihet asnjë dëmtim nga transporti ose dëmtim i sipërfaqes.
- Tubacionet dhe rubinetet duhet që të montohen, të shpëlahen dhe të kontrollohen sipas standardeve në fuqi
- Duhet të respektohen linjat udhëzuese të instalimit, të vlefshme për vendet respektive.

Përshkrimi i simbolit



Mos përdorni silikon që në përbërje ka acid acetik.



Komplet i gatshëm
(shih faqen 18)



Përmasat (shih faqen 42)



Pjesët e servisit (shih faqen 42)



Shenja e kontrollit (shih faqen 42)









⚠ تنبيهات الأمان

- ⚠ يجب إرتداء قفازات لليد أثناء التركيب لتجنب حدوث أخطار الإنحشار أو الجروح.
- ⚠ يجب أن يكون تيار الماء الساخن والماء البارد متعادلين في الضغط.

تعليمات التركيب

- قبل القيام بعملية التركيب، يجب فحص المنتج للتأكد من خلوه من أية تلفيات ناتجة عن النقل. بعد القيام بعملية التركيب، لن يتم الاعتراف بوجود أية تلفيات سطحية أو تلفيات ناتجة عن عملية النقل.
- يجب تركيب وغسيل واختبار التوصيلات وخلطات المياه طبقاً للمعايير السارية.
- يجب مراعاة القواعد الخاصة بالتركيب وأعمال السباكة وفقاً للوائح الخاصة بكل بلد.

وصف الرمز

- هام! لا تستخدم السليكون الذي يحتوي على أمضاض! 
- مجموعة كاملة. (راجع صفحة 18) 
- أبعاد (راجع صفحة 42) 
- قطع الغيار (راجع صفحة 42) 
- شهادة اختبار (راجع صفحة 42) 



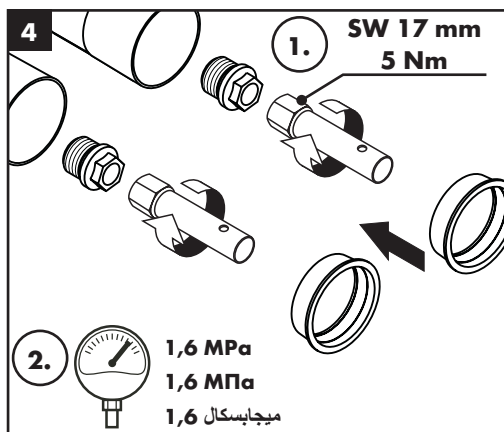
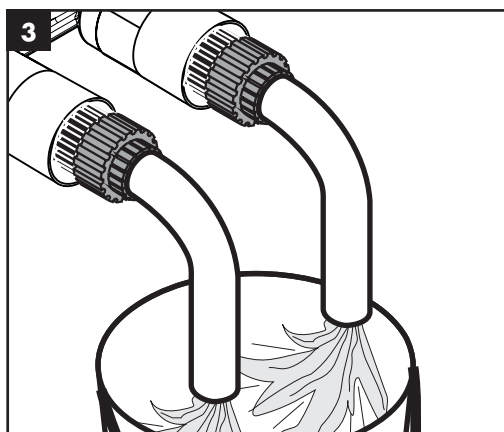
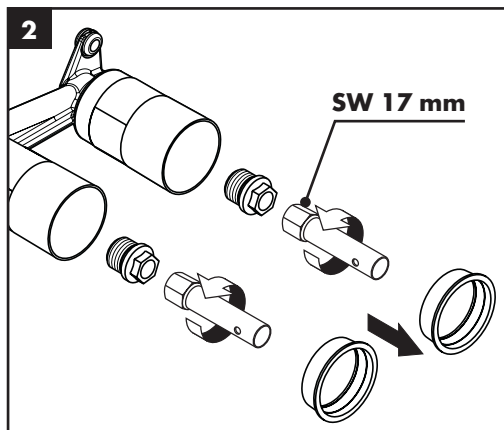
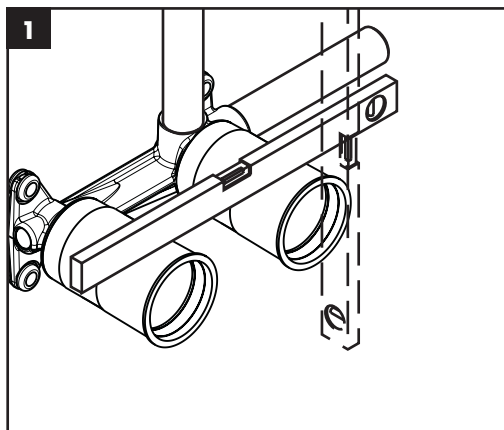
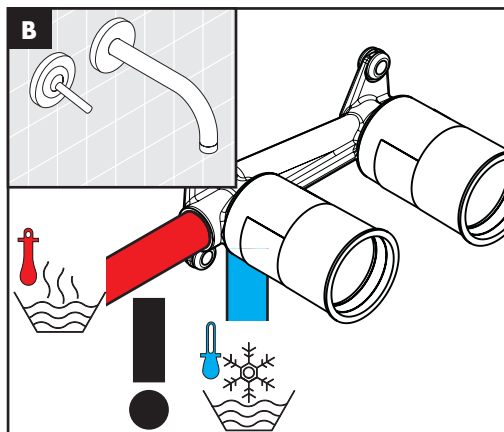
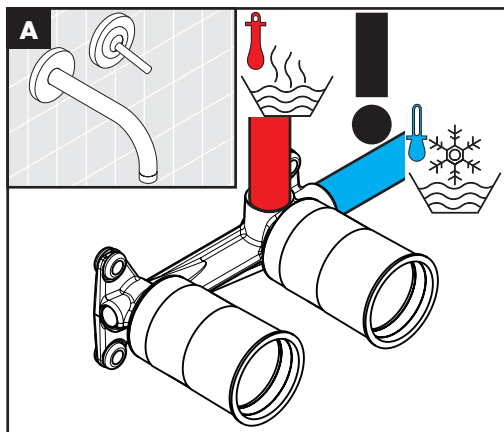



PuraVida 15084XXX / 15085XXX

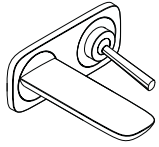

Metris 31085000 / 31251000 /
31086000

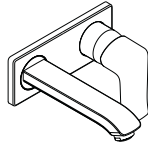

Metris Classic 31000XXX /
31003XXX

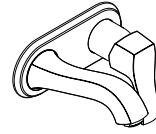

Metris S 31162000 / 31163000

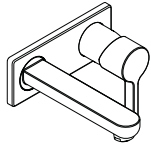

Talis 31618000 / 31620000 /
31611000

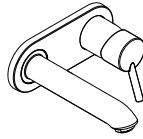

Logis 71220000

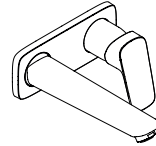

Talis E 71732000 / 71734000

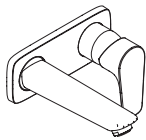

Talis S 72110000 / 72111000

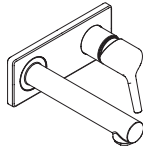

Metropol 32525000 / 32526000

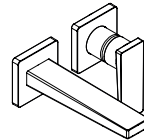

Metropol 74525000 / 74526000

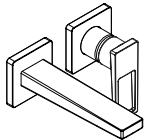



Bouroullec 19125000 / 19127000

Citterio M 34112000 / 34115000

Citterio M 34113000 / 34116000

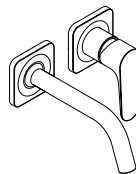
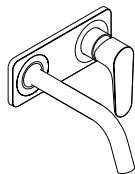
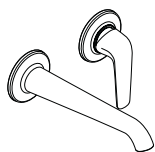

Uno 38112XXX / 38115XXX

Uno 38113XXX / 38116XXX

Citterio 39112XXX / 39115XXX

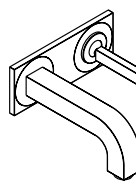
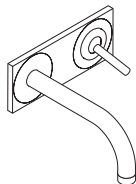

Citterio 39113XXX / 39116XXX

Citterio E 36106000

Citterio E 36114000

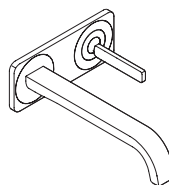
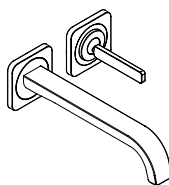
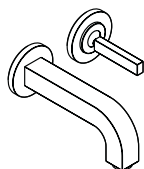

Uno 38121XXX / 38122XXX

Uno 45112XXX / 45113XXX

Uno 38815XXX

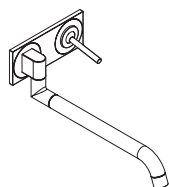
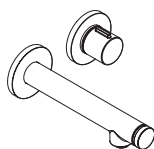
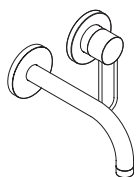



PuraVida 15084XXX

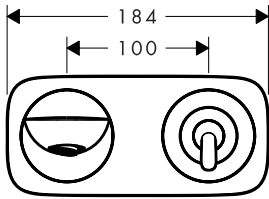
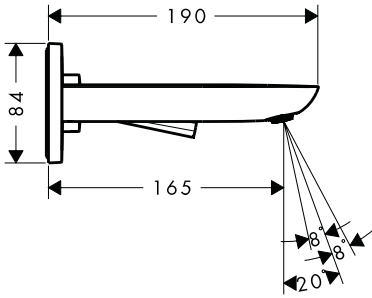

PuraVida 15085XXX

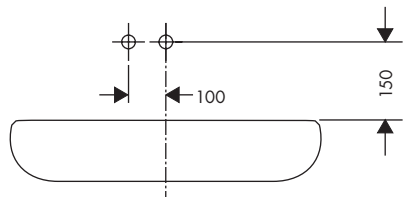
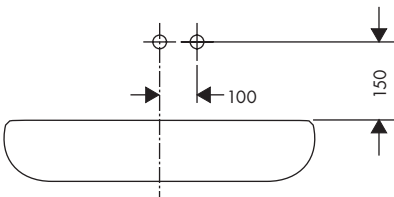
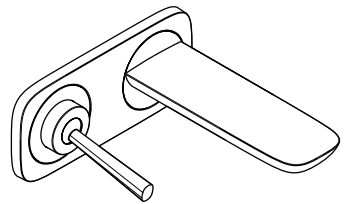
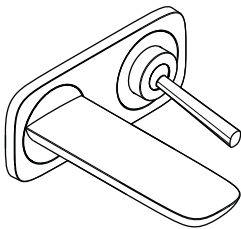
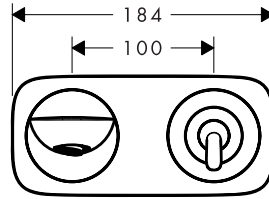
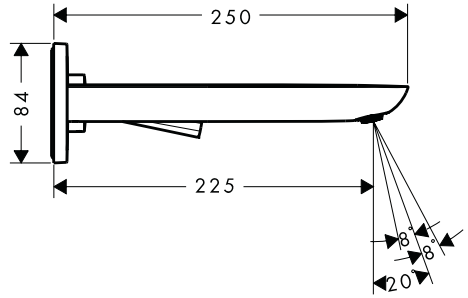



Metris 31085000 / 31251000

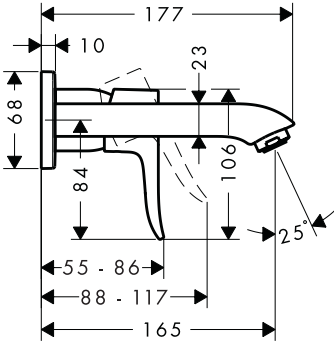

Metris 31086000

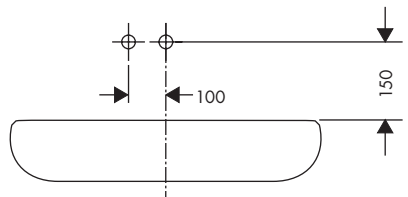
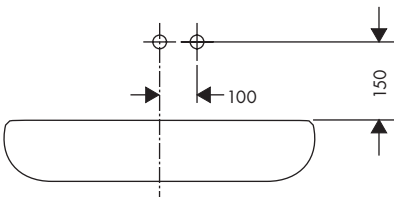
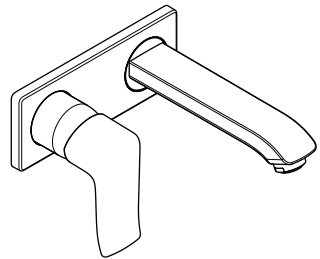
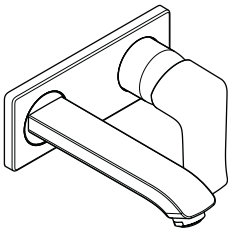
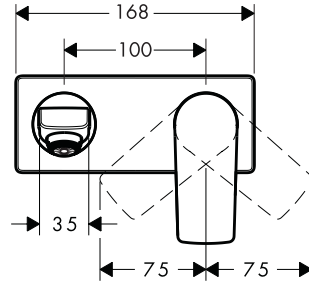
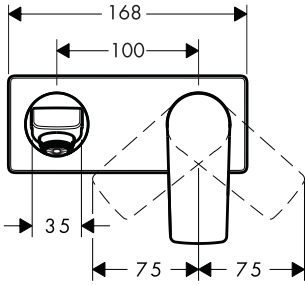
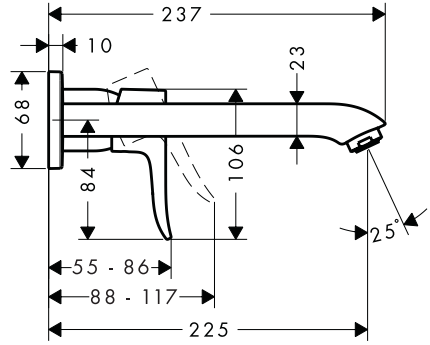



Metris Classic 31000XXX

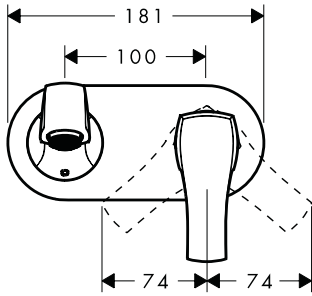
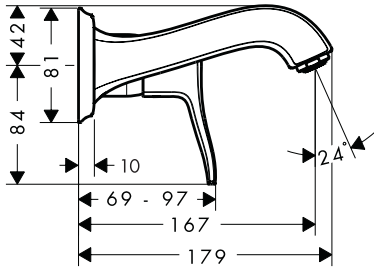

Metris Classic 31003XXX

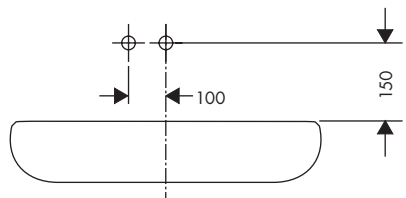
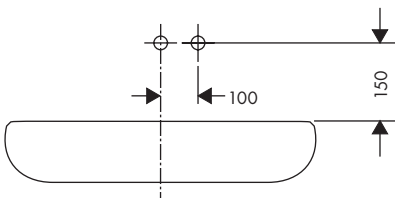
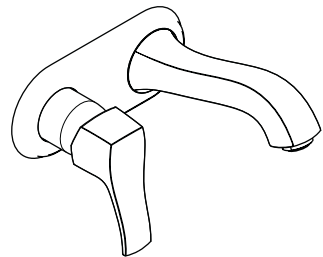
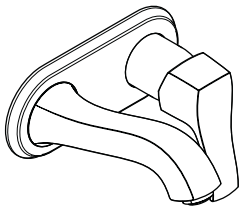
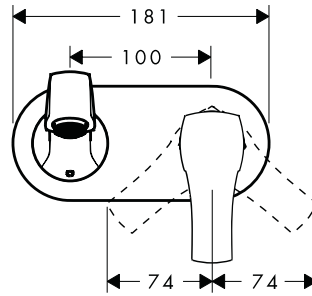
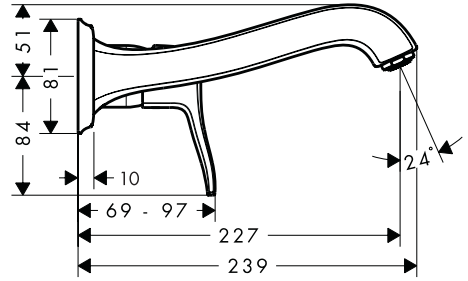



Metris S 31162000

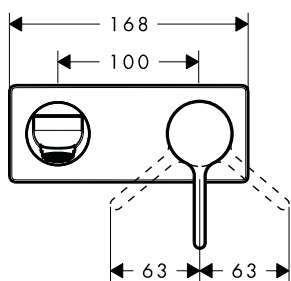
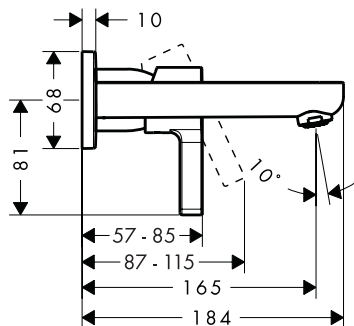

Metris S 31163000

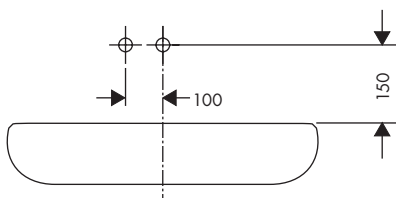
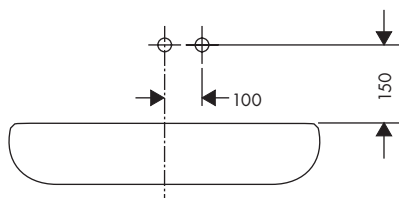
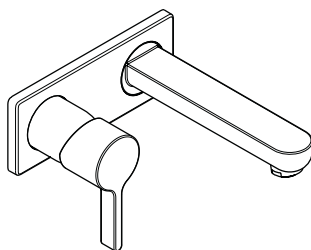
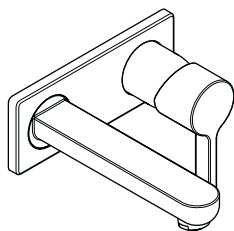
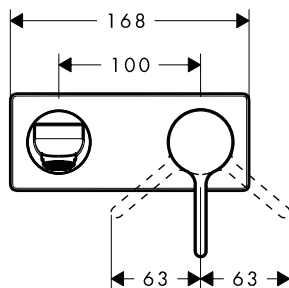
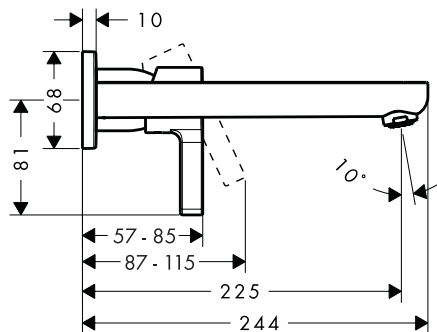



Talis 31618000 / 31620000

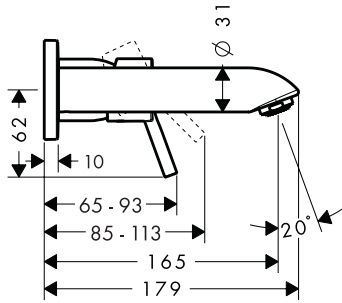

Talis 31611000

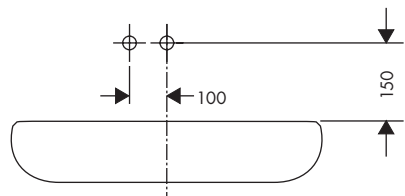
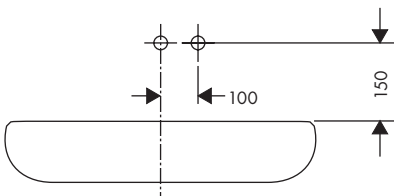
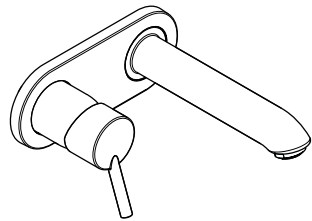
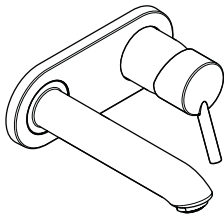
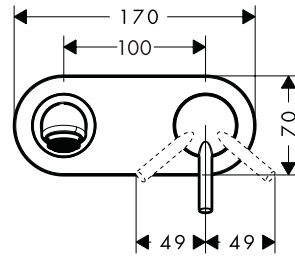
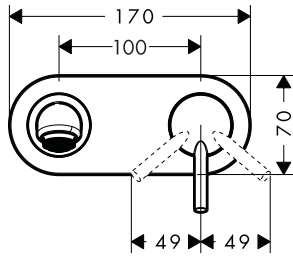
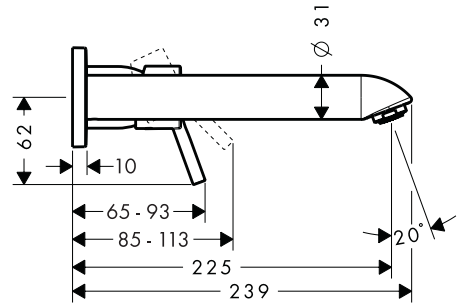



Logis 71220000

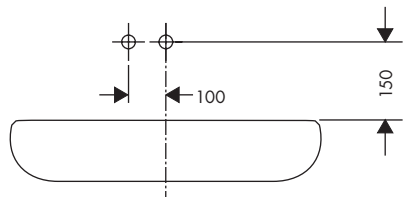
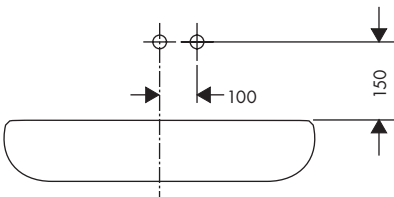
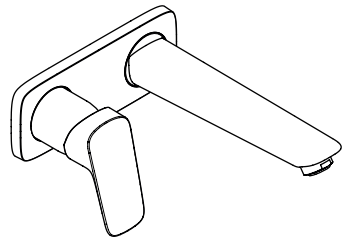
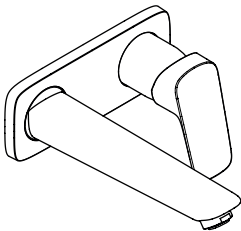
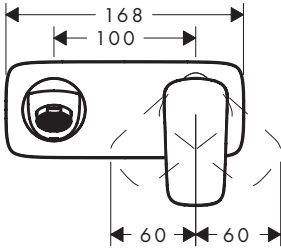
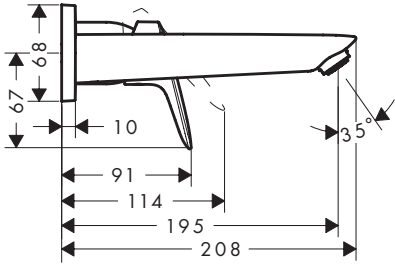



Talis E 71732000

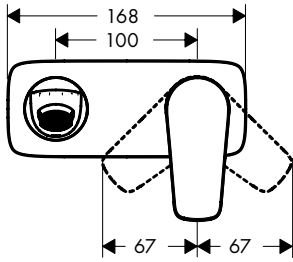
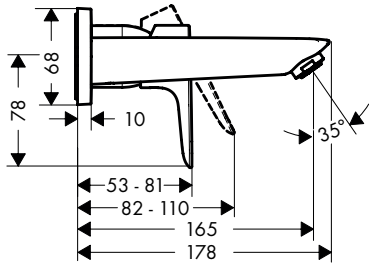

Talis E 71734000

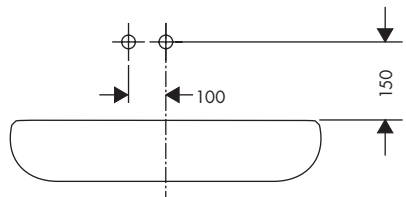
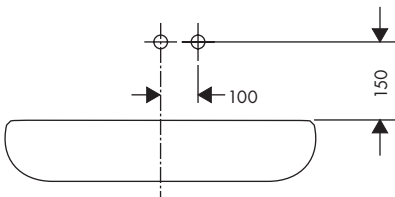
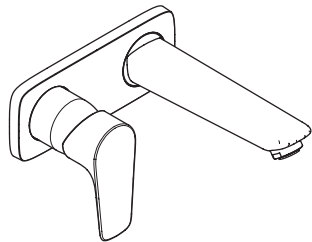
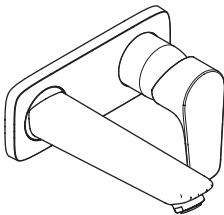
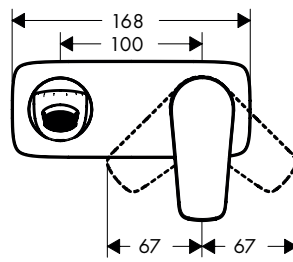
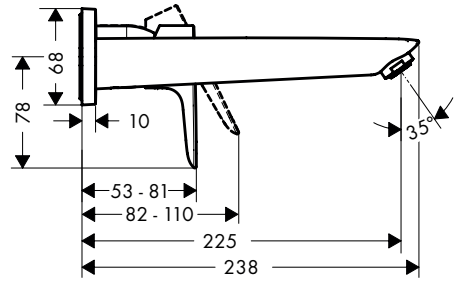



Talis S 72110000

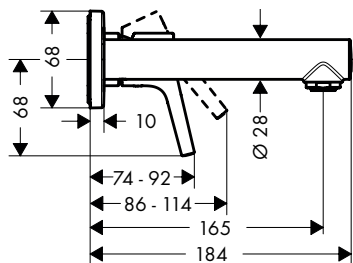

Talis S 72111000

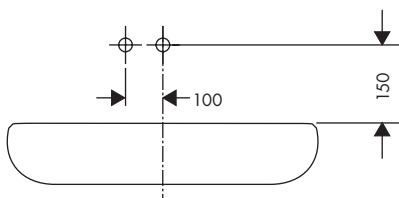
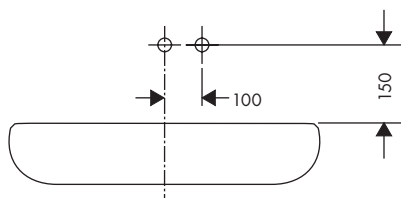
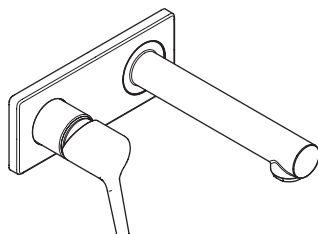
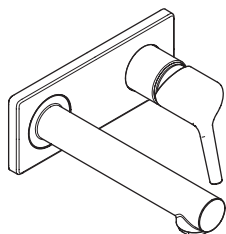
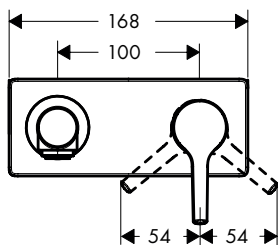
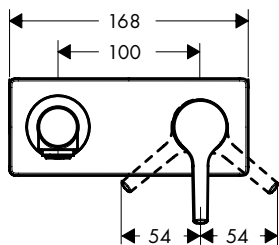
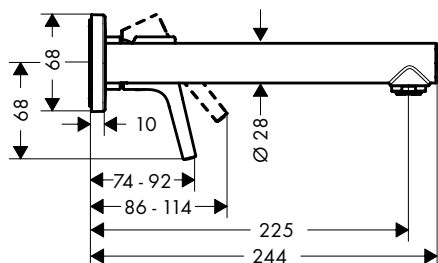



Metropol 32525000

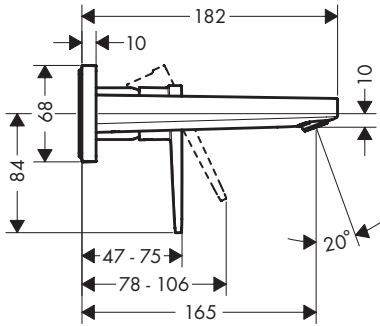

Metropol 32526000

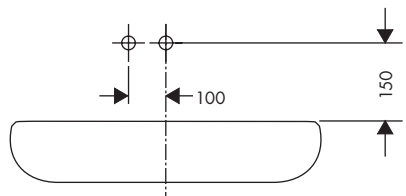
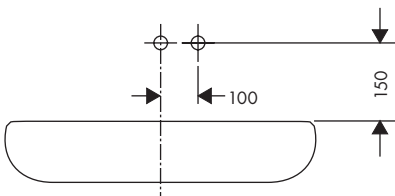
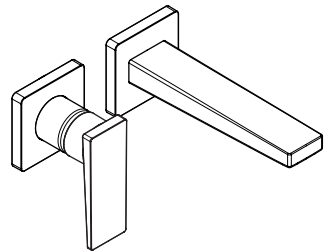
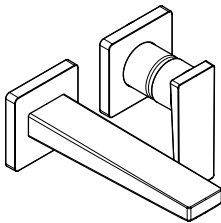
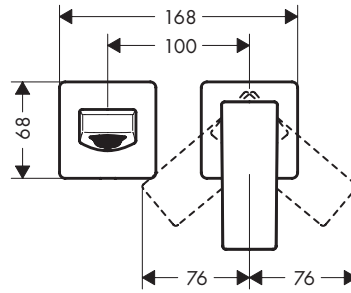
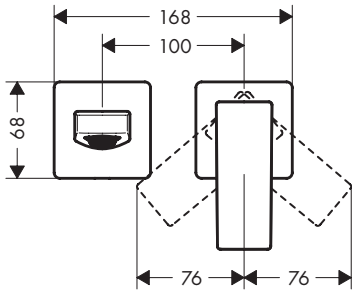
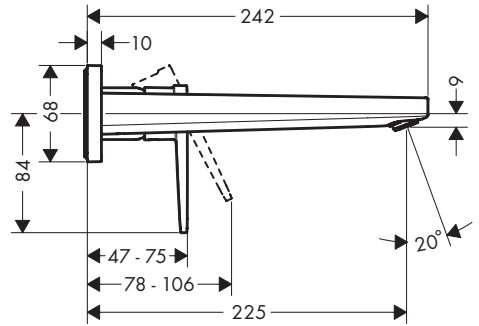



Metropol 74525000

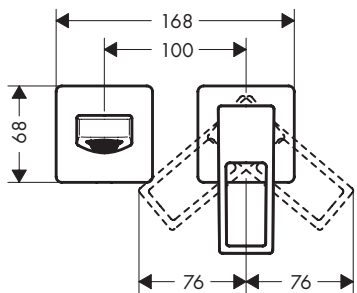
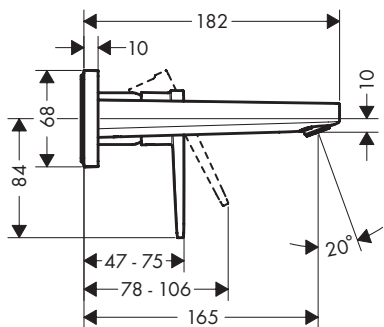

Metropol 74526000

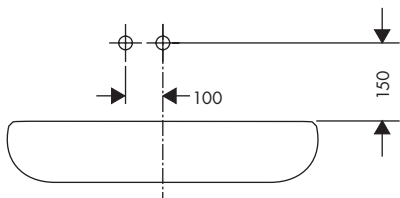
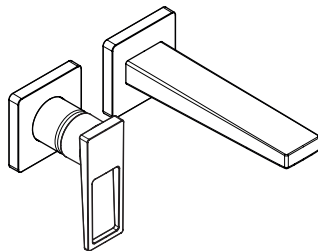
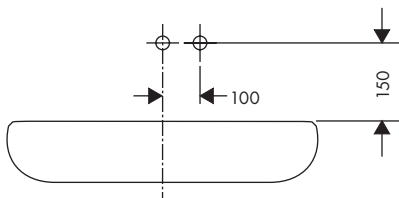
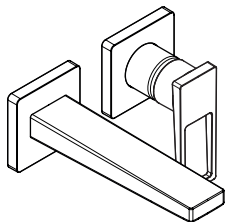
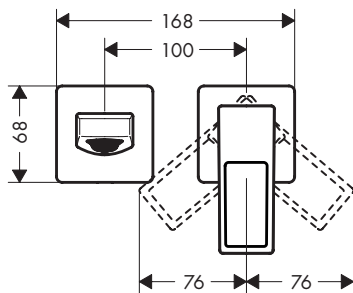
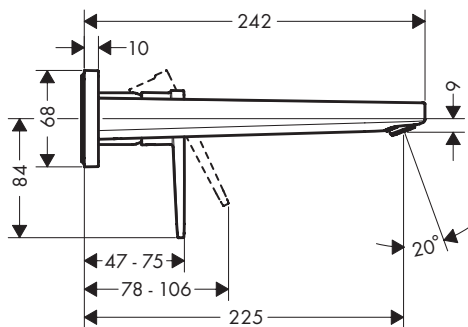



Bouroullec 19125000

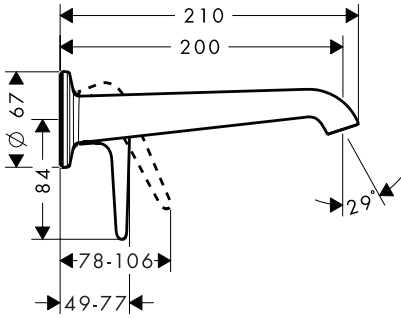

Bouroullec 19127000

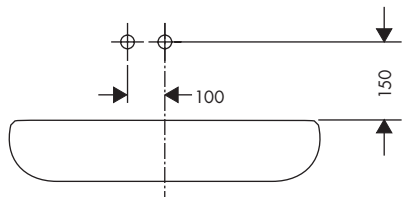
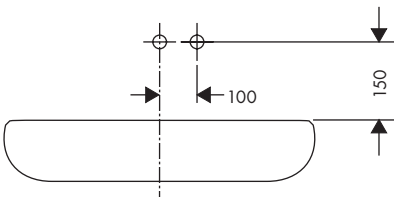
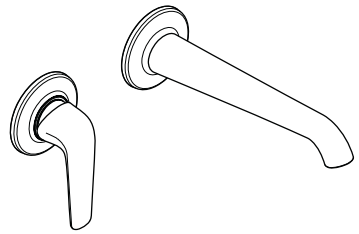
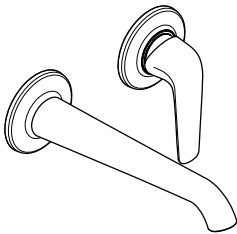
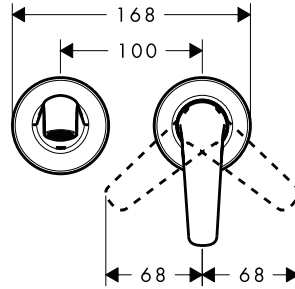
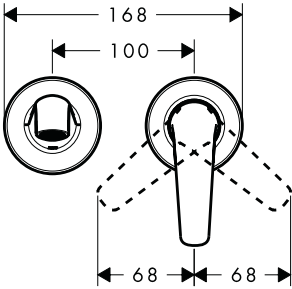
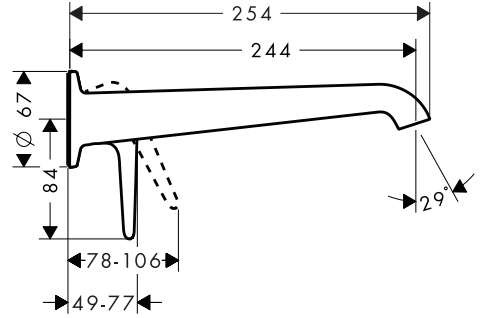



Citterio M 34112000

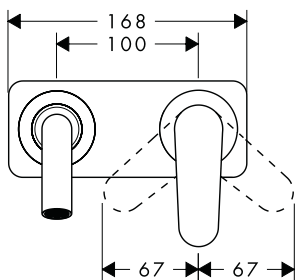
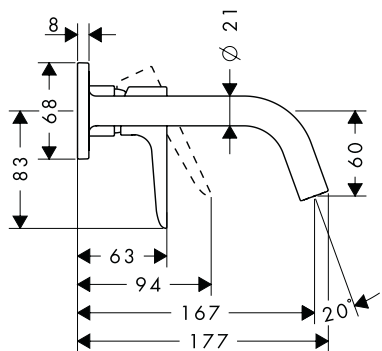

Citterio M 34115000

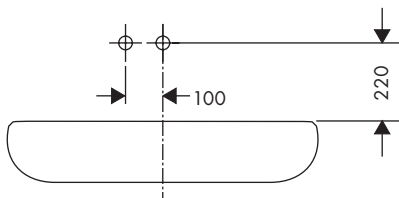
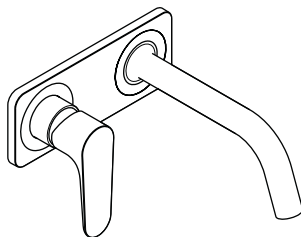
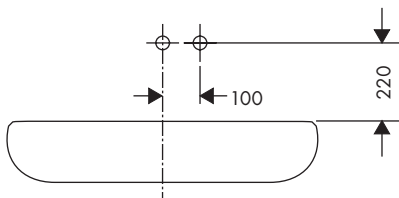
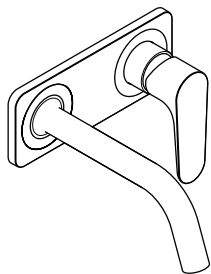
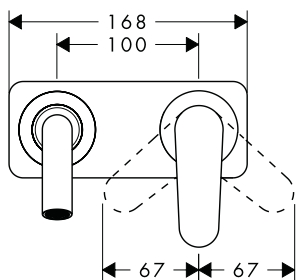
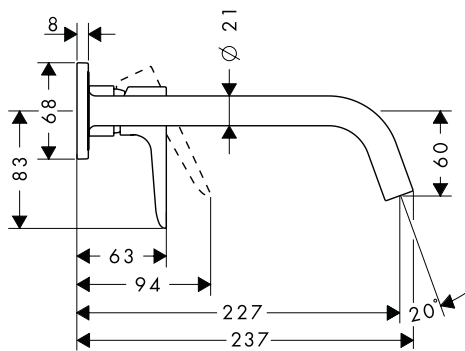



Citterio M 34113000

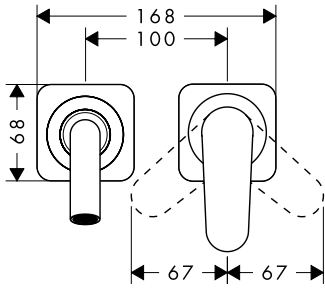
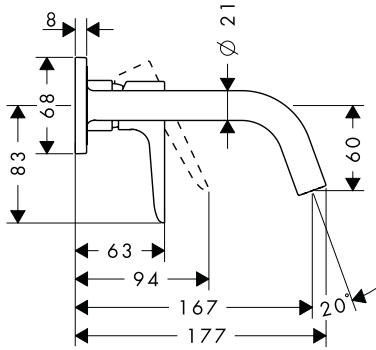

Citterio M 34116000

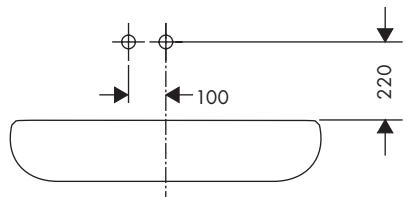
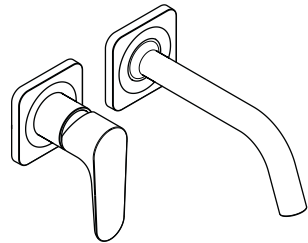
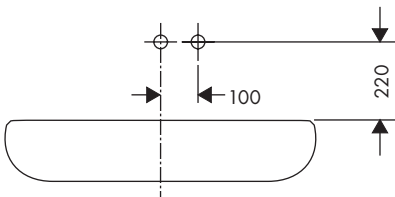
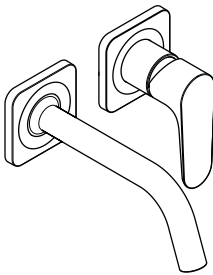
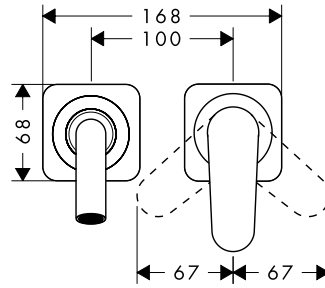
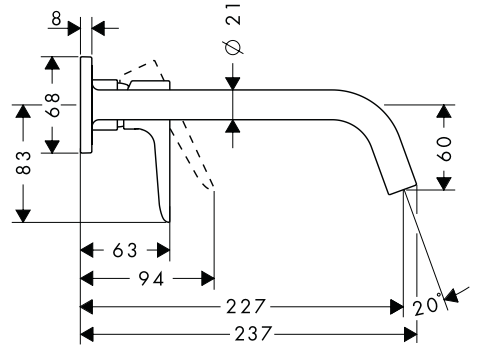



Uno 38112XXX

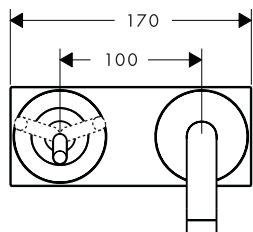
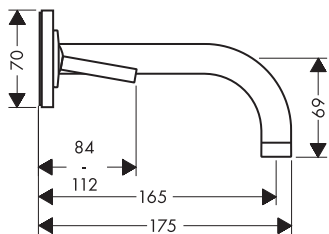

Uno 38115XXX

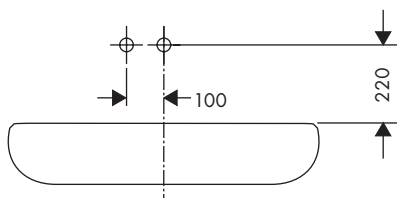
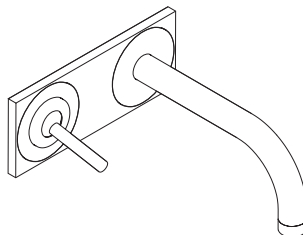
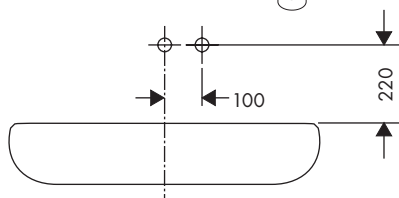
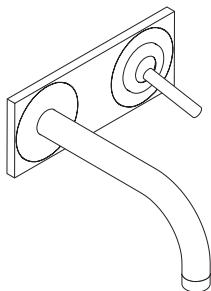
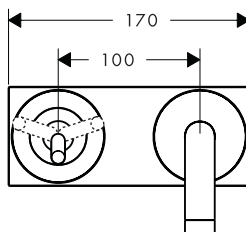
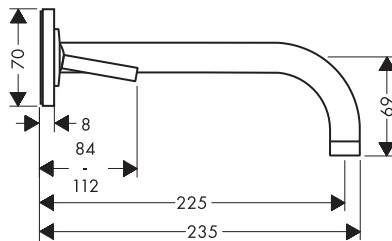



Uno 38113XXX

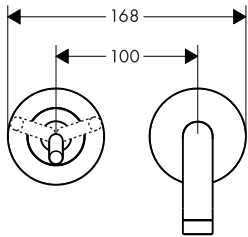
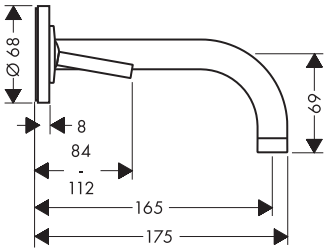

Uno 38116XXX

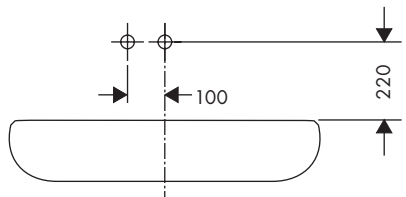
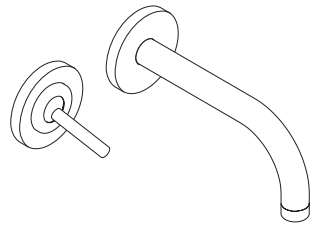
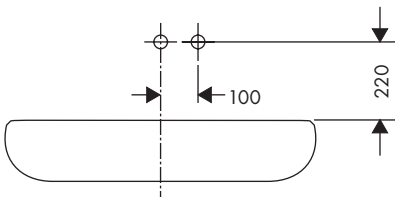
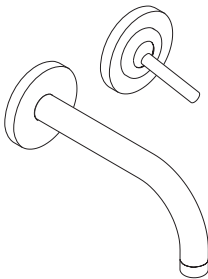
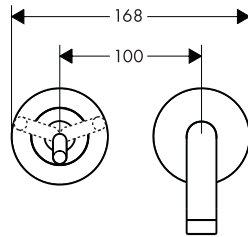
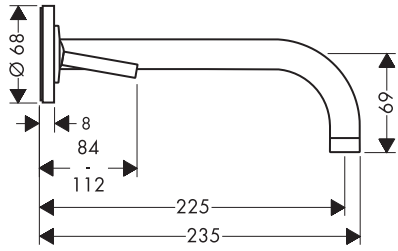



Citterio 39112XXX

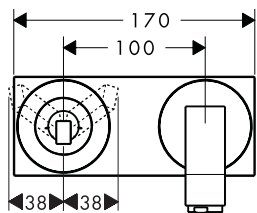
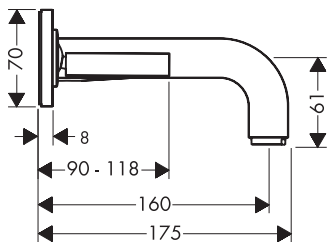

Citterio 39115XXX

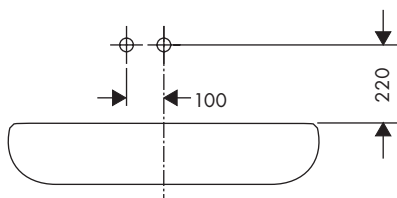
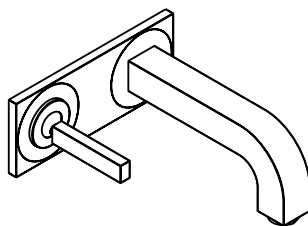
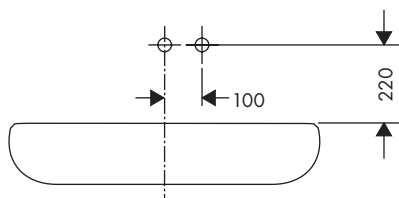
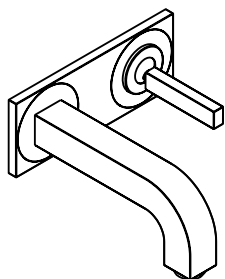
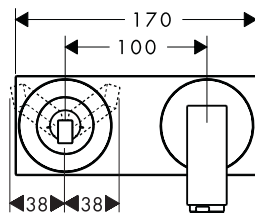
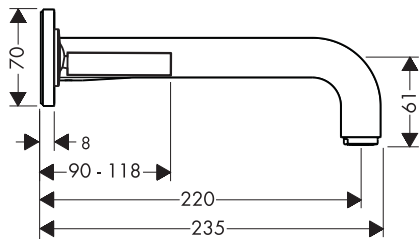



Citterio 39113XXX

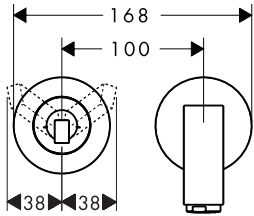
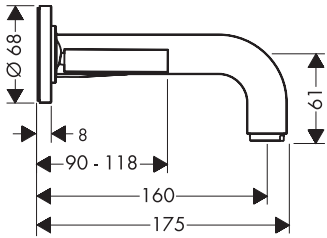

Citterio 39116XXX

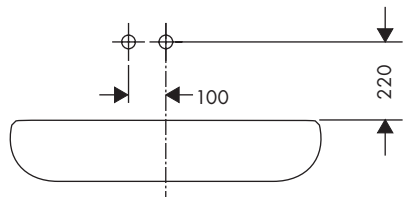
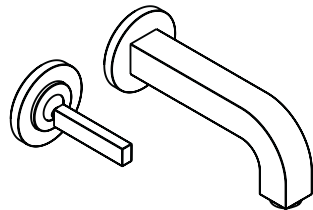
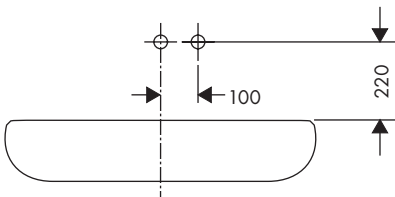
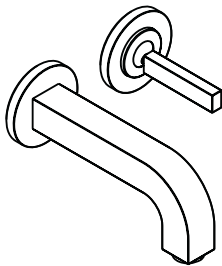
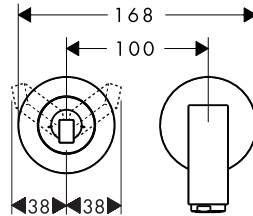
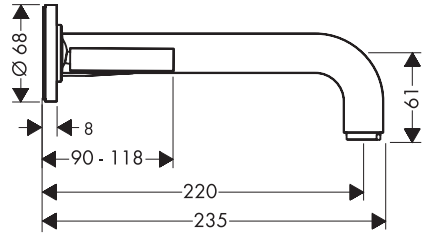



Criterio E 36106000

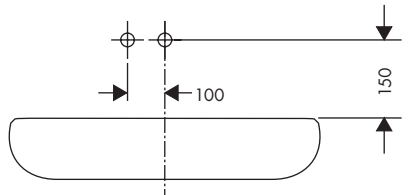
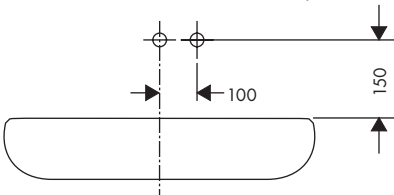
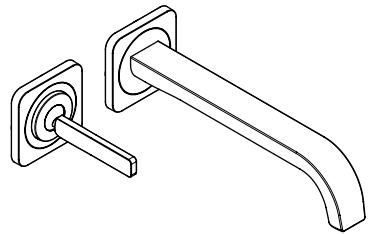
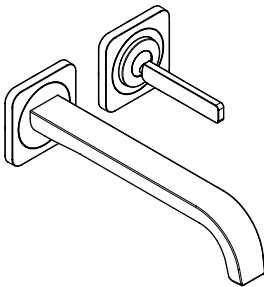
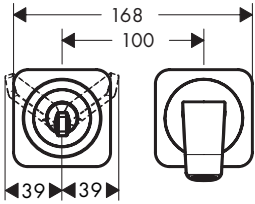
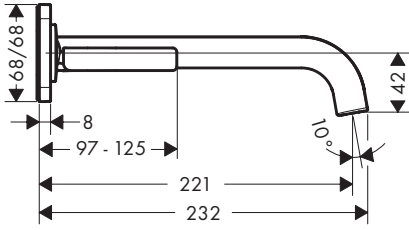



Citterio E 36114000

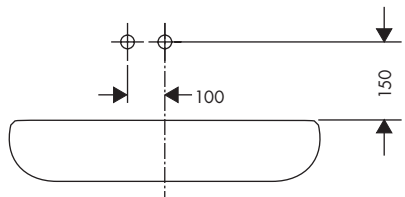
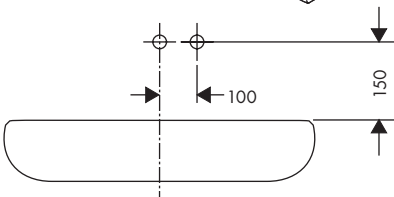
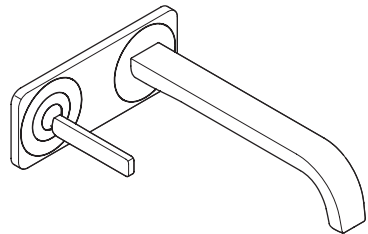
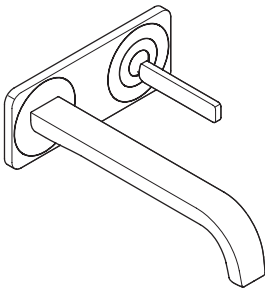
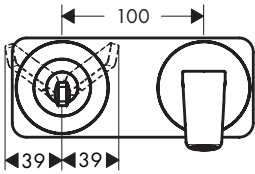
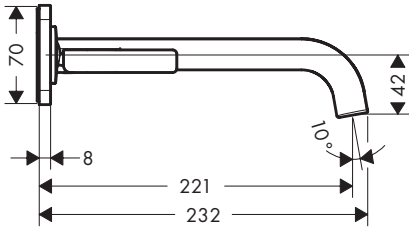



Uno 38121XXX

Uno 38122XXX

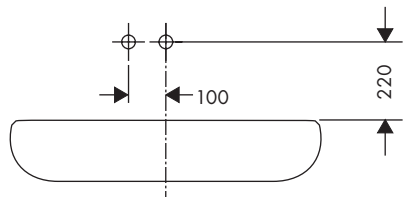
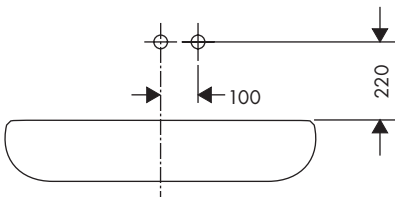
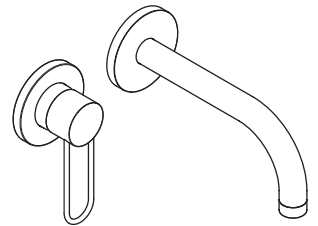
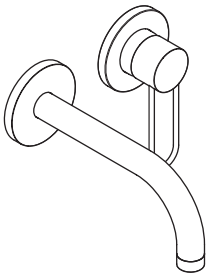
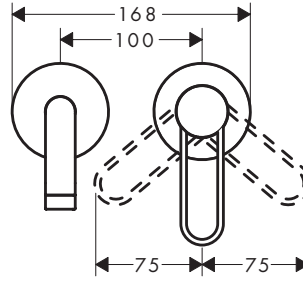
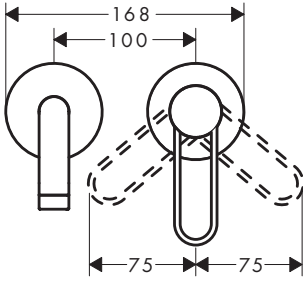
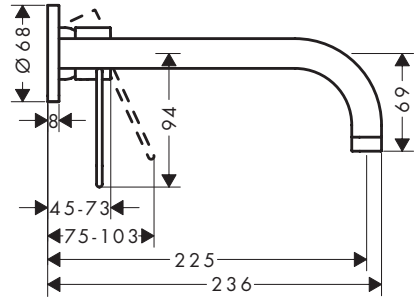
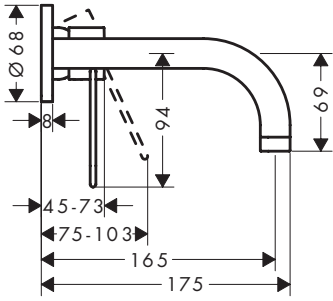



Uno 45112XXX

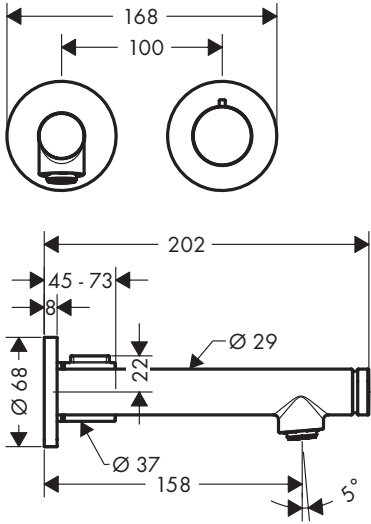

Uno 45113XXX

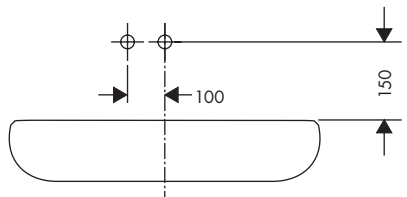
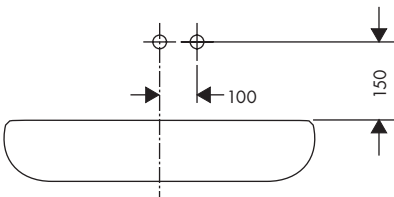
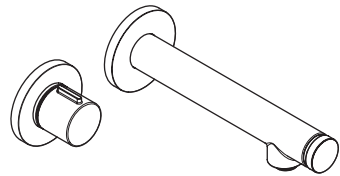
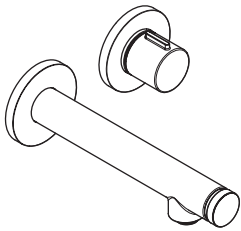
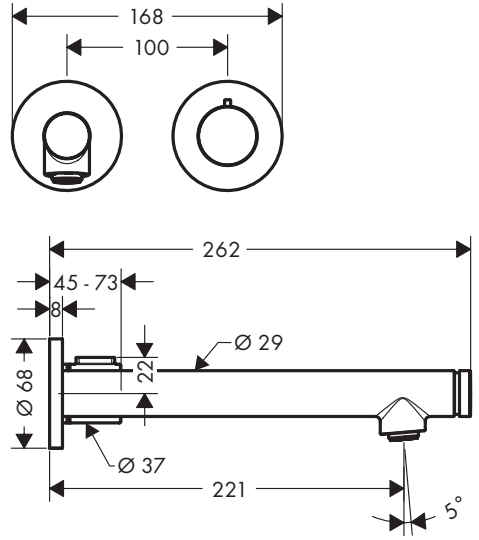



Uno 38815XXX

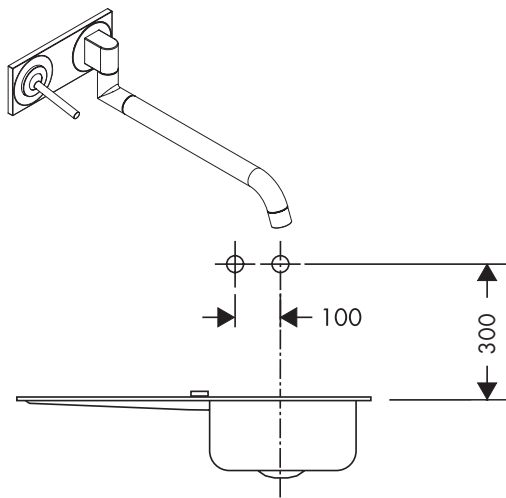
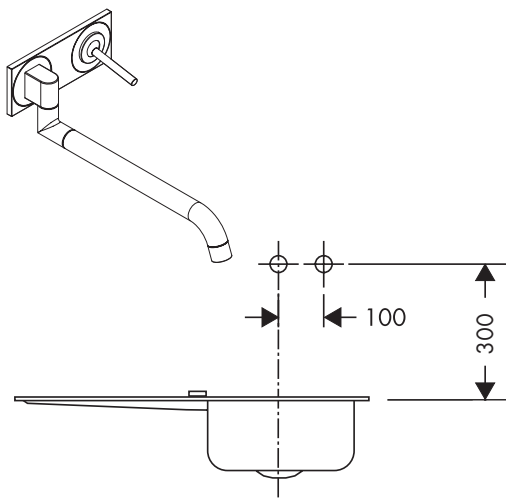
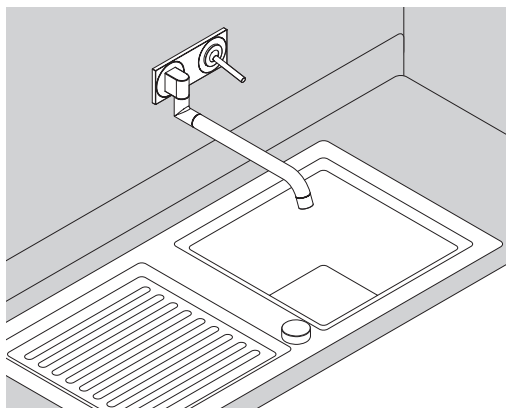
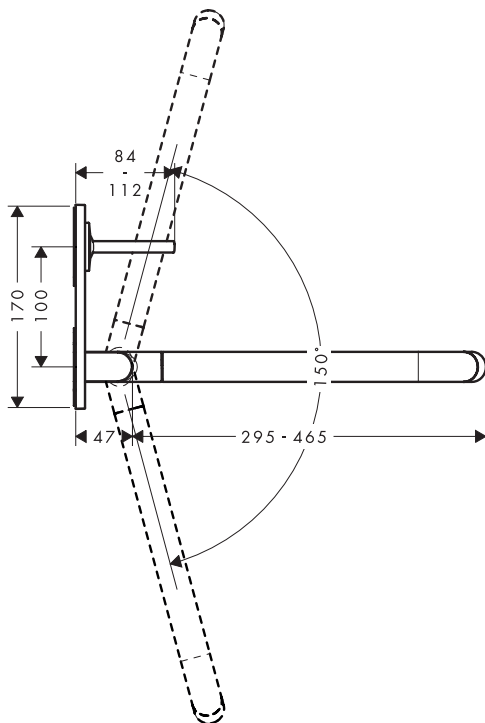
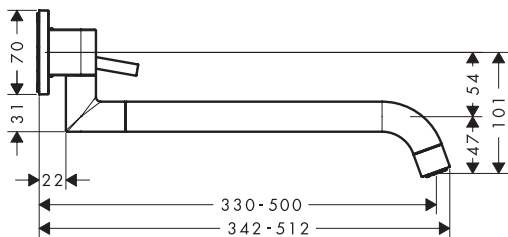

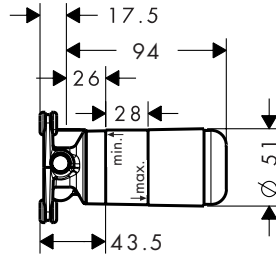
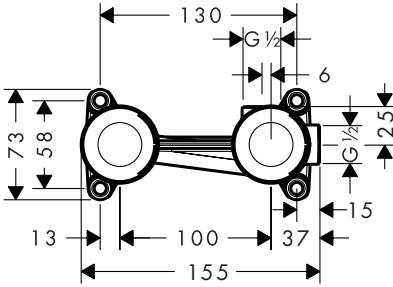

P-IX

ACS

SVGW

WRAS



ETA



GODKENDT TIL DRILKEVAND

13622180

X

X

1395

vd1.42/19221

04/00001

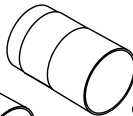
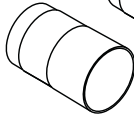
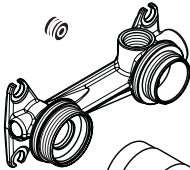

92112000
(24x3)



SW 30mm

98181000
(18x2,5)

SW 17mm

31971000

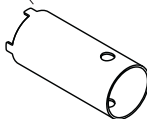

98181000
(18x2,5) SW 17mm

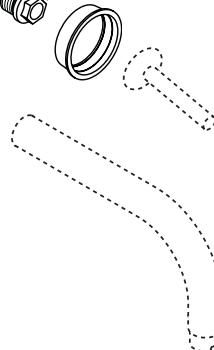









hansgrohe

Hansgrohe · AuestraÙe 5 · 9 · D-77761 Schiltach · Telefon +49 (0) 78 36/51-1282 · Telefax +49 (0) 7836/511440
E-Mail: info@hansgrohe.com · Internet: www.hansgrohe.com

08/2017
9,01079,01