

<b>DE</b>	Gebrauchsanleitung / Montageanleitung	<b>2</b>
<b>FR</b>	Mode d'emploi / Instructions de montage	<b>3</b>
<b>EN</b>	Instructions for use / assembly instructions	<b>4</b>
<b>IT</b>	Istruzioni per l'uso / Istruzioni per Installazione	<b>5</b>
<b>ES</b>	Modo de empleo / Instrucciones de montaje	<b>6</b>
<b>NL</b>	Gebruiksaanwijzing / Handleiding	<b>7</b>
<b>DK</b>	Brugsanvisning / Monteringsvejledning	<b>8</b>
<b>PT</b>	Instruções para uso / Manual de Instalação	<b>9</b>
<b>PL</b>	Instrukcja obsługi / Instrukcja montażu	<b>10</b>
<b>CS</b>	Návod k použití / Montážní návod	<b>11</b>
<b>SK</b>	Návod na použitie / Montážny návod	<b>12</b>
<b>ZH</b>	用户手册 / 组装说明	<b>13</b>
<b>RU</b>	Руководство пользователя / Инструкция по монтажу	<b>14</b>
<b>HU</b>	Használati útmutató / Szerelési útmutató	<b>15</b>
<b>FI</b>	Käyttöohje / Asennusohje	<b>16</b>
<b>SV</b>	Bruksanvisning / Monteringsanvisning	<b>17</b>
<b>LT</b>	Vartotojo instrukcija / Montavimo instrukcijos	<b>18</b>
<b>HR</b>	Upute za uporabu / Uputstva za instalaciju	<b>19</b>
<b>TR</b>	Kullanım kılavuzu / Montaj kılavuzu	<b>20</b>
<b>RO</b>	Manual de utilizare / Instrucțiuni de montare	<b>21</b>
<b>EL</b>	Οδηγίες χρήσης / Οδηγία συναρμολόγησης	<b>22</b>
<b>SL</b>	Navodilo za uporabo / Navodila za montažo	<b>23</b>
<b>ET</b>	Kasutusjuhend / Paigaldusjuhend	<b>24</b>
<b>LV</b>	Lietošanas pamācība / Montāžas instrukcija	<b>25</b>
<b>SR</b>	Uputstvo za upotrebu / Uputstvo za montažu	<b>26</b>
<b>NO</b>	Bruksanvisning / Montasjeveiledning	<b>27</b>
<b>BG</b>	Инструкция за употреба / Ръководство за монтаж	<b>28</b>
<b>SQ</b>	Udhëzuesi i përdorimit / Udhëzime rreth montimit	<b>29</b>
<b>AR</b>	دليل الاستخدام / تعليمات التجميع	<b>30</b>

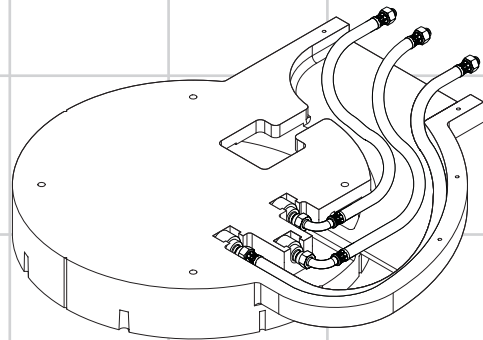

**Rainmaker**  
28412180

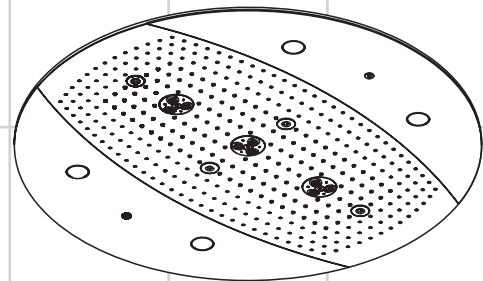

**Rainmaker**  
28403000 / 28404000

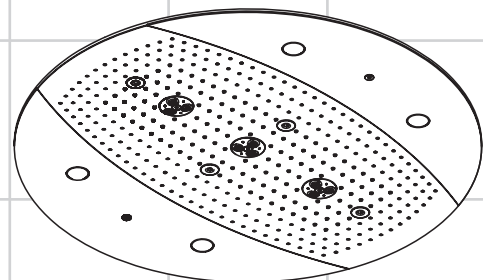

**Rainmaker**  
26115000 / 26117000



## Sicherheitshinweise

- ⚠ Bei der Montage müssen zur Vermeidung von Quetsch- und Schnittverletzungen Handschuhe getragen werden.
- ⚠ Das Produkt darf nur zu Bade-, Hygiene- und Körperreinigungszwecken eingesetzt werden.
- ⚠ Kinder, sowie Erwachsene mit körperlichen, geistigen und / oder sensorischen Einschränkungen dürfen das Produkt nicht unbeaufsichtigt benutzen. Personen, die unter Alkohol- oder Drogeneinfluss stehen, dürfen das Produkt nicht benutzen.
- ⚠ Der Kontakt der Brausestrahlen mit empfindlichen Körperstellen (z. B. Augen) muss vermieden werden. Es muss ein ausreichender Abstand zwischen Brause und Körper eingehalten werden.
- ⚠ Große Druckunterschiede zwischen den Kalt- und Warmwasseranschlüssen müssen ausgeglichen werden.

## Elektroanschluss

- ⚠ Der Elektroanschluss darf nur vom Elektrofachmann durchgeführt werden!
- ⚠ Spannungsversorgung 100-240V/N/PE/50-60Hz (Länge: 0,3 m) vorinstallieren.
- ⚠ Die Absicherung muss über eine Fehlerstrom-Schutzeinrichtung (RCD/ FI) mit einem Bemessungsdifferenzstrom  $\leq 30$  mA erfolgen.
- ⚠ Das Produkt muss an einen bauseits vorhandenen Potentialausgleich (PA) 4 mm<sup>2</sup> angeschlossen werden.

## Elektroinstallateur

- ⚠ Die Installations- und Prüfungsarbeiten sind von einer zugelassenen Elektrofachkraft, unter Berücksichtigung von VDE 0100 Teil 701, IEC 60364-6 u. IEC 60364-7-701 sowie EN 60335-2-105, auszuführen.
- ⚠ Die Netzanschlussleitung muss doppelt isoliert in die Anschlussdose eingeführt werden.

## Montagehinweise

- Vor der Montage muss das Produkt auf Transportschäden untersucht werden. Nach dem Einbau werden keine Transport- oder Oberflächenschäden anerkannt.
- Die Leitungen und die Armatur müssen nach den gültigen Normen montiert,

gespült und geprüft werden.

- Die in den Ländern jeweils gültigen Installationsrichtlinien sind einzuhalten.
- Bei der Montage des Produktes durch qualifiziertes Fachpersonal ist darauf zu achten, dass die Befestigungsfläche im gesamten Bereich der Befestigung plan ist (keine vorstehenden Fugen oder Fliesenversatz), der Wandaufbau für eine Montage des Produktes geeignet ist und keine Schwachstellen aufweist.
- Beim Bohren auf Strom- und Wasserleitungen achten!
- Die Ablaufleistung muss ausreichend dimensioniert werden.
- Die Brause darf nur nach einem Absperrventil oder einer Sanitärarmatur angeschlossen werden.

## Technische Daten

Betriebsdruck vor der Armatur:	max. 1 MPa
Empfohlener Betriebsdruck: (1 MPa = 10 bar = 147 PSI)	0,3 - 0,5 MPa
Heißwassertemperatur:	max. 60 °C
Empfohlene Heißwassertemperatur:	42 °C
Sicherheitsperre:	40 °C
<b>Warnhinweis: Eine Überschreitung dieser Temperatur kann zu Verbrennungen führen!</b>	
Thermische Desinfektion:	max. 70 °C / 4 min
Nennspannung	100-240V AC 50-60Hz
Nennaufnahme	18 W
Leuchten 4 x LED:	12V DC SELV 4 W
Das Leuchtmittel ist nicht dimmbar.	
Schutzklasse	II
Schutzart	IPX5

## Symbolerklärung

- Kein essigsäurehaltiges Silikon verwenden!
- Maße** (siehe Seite 32)
- Montagebeispiele** (siehe Seite 34)
- Bedienung** (siehe Seite 31)
- Serviceteile** (siehe Seite 31)
- Service Leuchtmittel austauschen** (siehe Seite 52)
- Reinigung** (siehe Seite 50) und beiliegende Broschüre
- Elektroinstallateur**
- Wartung** (siehe Seite 53)
- Die Sicherheitseinrichtungen müssen gemäß DIN EN 1717 regelmäßig in Übereinstimmung mit nationalen oder regionalen Bestimmungen (DIN 1988 einmal jährlich) auf ihre Funktion geprüft werden.

- Wasseranschluss DN20
- Warmwasser
- Wasseranschluss DN20
- Kaltwasser
- Unterputz-Ventil
- Quattro Vierwegeumstellung
- Trio Universal Absperr- und Umstellventil
- Thermostat HighFlow
- Die Ablaufleistung muss mehr als 50 l/min betragen.
- Ablauf
- Raindrain
- Mitte Duschwanne
- Wasser öffnen / Wasser abstellen

- Leerrohr für Stromversorgung
- Warnung vor heißer Oberfläche!
- Schutzhandschuhe tragen
- Augenschutz tragen
- Naturschwamm**
- Entkalker** (zitronensäurebasis)
- Augen- und Hautkontakt vermeiden. Falls das Produkt in die Augen gelangt, diese gründlich mit Wasser ausspülen.
- Strom an / aus
- Prüfzeichen** (siehe Seite 54)



**Montage Grundset siehe Seite 42**



**Montage Fertigset siehe Seite 47**



**Consignes de sécurité**

- ⚠ Lors du montage, porter des gants de protection pour éviter toute blessure par écrasement ou coupure.
- ⚠ Le produit ne doit servir qu'à se laver et à assurer l'hygiène corporelle.
- ⚠ Il est interdit aux enfants ainsi qu'aux adultes ayant des insuffisances physiques, psychiques et/ou motoriques d'utiliser la douche sans surveillance. De même, il est interdit à des personnes sous influence d'alcool ou de drogues d'utiliser la douche.
- ⚠ Éviter le contact du jet de la douchette avec les parties sensibles du corps (telles par ex. que les yeux). Veiller à respecter un écart suffisant entre la douchette et le corps
- ⚠ Il est conseillé d'équilibrer les pressions de l'eau chaude et froide.

**⚡ Raccord électrique**

- ⚠ Seul un spécialiste est autorisé à réaliser le câblage!
- ⚠ Pré-installer l'alimentation en tension de 100-240V/N/PE/50-60Hz (longueur : 0,3 m).
- ⚠ La protection par fusibles doit se faire avec un dispositif de protection par courant de défaut (RCD/ FI) avec un courant différentiel résiduel de maximum 30 mA.
- ⚠ Le produit doit être raccordé à une liaison équipotentielle du propriétaire (PA) 4 mm<sup>2</sup>.

**⚡ Électricien installateur**

- ⚠ Les travaux d'installation et de contrôle doivent être confiés à un électricien agréé, en respectant VDE 0100 partie 701, IEC 60364-6 et IEC 60364-7-701 ainsi que EN 60335-2-105.
- ⚠ Le câble secteur doit être introduit dans la prise de raccord, avec une double isolation

**Instructions pour le montage**

- Avant son montage, s'assurer que le produit n'a subi aucun dommage pendant le transport. Après le montage, tout dommage de transport ou de surface ne pourra pas être reconnu.
- Les conduites et la robinetterie doivent être montés, rincés et contrôlés selon les

normes en vigueur.

- Les directives d'installation en vigueur dans le pays concerné doivent être respectées.
- Lors du montage de ce produit par du personnel qualifié, veiller à ce que la surface de fixation soit bien plane dans toute la zone de fixation (pas de dépassement de joints ou de déport de carreaux), à ce que le mur se prête au montage du produit et ne présente aucun point fragile.
- Lors de travaux de perçage sur des conduites électriques et des conduites d'eau!
- Le débit du vidage doit être suffisamment dimensionné.
- La douchette ne doit être raccordée qu'en aval d'une vanne d'arrêt ou d'une robinetterie sanitaire.

**Informations techniques**

Pression de service devant la robinetterie:	max. 1 MPa
Pression de service conseillée:	0,3 - 0,5 MPa
(1 MPa = 10 bar = 147 PSI)	
Température d'eau chaude:	max. 60 °C
Température recommandée:	42 °C
Blocage de sécurité:	40 °C
<b>Avertissement: tout dépassement de cette température peut entraîner des brûlures</b>	
Désinfection thermique:	max. 70 °C / 4 min
Tension nominale	100-240V AC 50-60Hz
Consommation nominale	18 W
Lampes 4 x LED:	12V DC SELV 4 W
Source lumineuse dont la luminosité ne peut pas être atténuée.	
Classe de protection	II
Mode de protection	IPX5

**Description du symbole**

Ne pas utiliser de silicone contenant de l'acide acétique!

**Dimensions** (voir pages 32)

**Exemples de montage** (voir pages 34)

**Instructions de service** (voir pages 31)

**Pièces détachées** (voir pages 31)

**Service Remplacer l'élément lumineux** (voir pages 52)

**Nettoyage** (voir pages 50) et brochure ci-jointe

**Électricien installateur**

**Entretien** (voir pages 53)

Les clapets anti-retour doivent être examinés régulièrement conformément à la norme EN 1717 ou conformément aux dispositions nationales ou régionales quant à leur fonction (au moins une fois par an).

Raccord d'eau DN20

Eau chaude

Raccord d'eau DN20

Eau froide

Robinet d'arrêt encastré

Quattro inverseur quatre voies

**Quattro**

Trio Robinet d'arrêt avec inverseur

**Trio**

Mitigeur thermostatique HighFlow

**High Flow**

Le débit de vidage doit être supérieur à 50 l/min.

**> 50 l/min**

Vidage

**Raindrain**

Centre cuvette de douche

**X**

Ouvrir l'eau. / Couper l'arrivée d'eau

Gaine pour alimentation en courant électrique

Attention à la température élevée à la surface !

Protection obligatoire des mains

Protection obligatoire de la vue

**éponge naturelle**

**Détartrant** (À base d'acide citrique)

Éviter tout contact avec les yeux et la peau. Si le produit saute aux yeux, rincer ces derniers à l'eau abondante

Courant marche / arrêt

**Classification acoustique et débit** (voir pages 54)

**Montage Kit de base voir pages 42**

**Montage Set de finition voir pages 47**



## Safety Notes

- ⚠️ Gloves should be worn during installation to prevent crushing and cutting injuries.
- ⚠️ The product may only be used for bathing, hygienic and body cleaning purposes.
- ⚠️ Children as well as adults with physical, mental and/or sensoric impairments must not use this product without proper supervision. Persons under the influence of alcohol or drugs are prohibited from using this product.
- ⚠️ Do not allow the streams of the shower touch sensitive body parts (such as your eyes). An adequate distance must be kept between the shower and you.
- ⚠️ The hot and cold supplies must be of equal pressures.

### Electrical connection

- ⚠️ The electrical connection may only be carried out by an electrician!
- ⚠️ Pre-install voltage supply 100-240V/N/PE/50-60Hz (length: 0,3).
- ⚠️ The system must be protected via a leakage current protective device (RCD/FI) with a measurement difference current of  $\leq 30$  mA.
- ⚠️ The product must be connected to 4 mm<sup>2</sup> equipotential bonding (PA) to be provided by the customer.

### Electrician

- ⚠️ The installation and testing work must be performed by a skilled electrician in observance of VDE 0100 part 701, IEC 60364-6 and IEC 60364-7-701 as well as EN 60335-2-105.
- ⚠️ The mains connection line must be inserted into the connection socket with double insulation

## Installation Instructions

- Prior to installation, inspect the product for transport damages. After it has been installed, no transport or surface damage will be honoured.
- The pipes and the fixture must be installed, flushed and tested as per the applicable standards.
- The plumbing codes applicable in the respective countries must be observed.
- During installation of the product by qualified trained personnel, make sure that the entire fastening surface is even and smooth (no protruding seams or tile

offset), that the finish of the wall is suitable to apply the product and has no weak points.

- Observe all current and water lines when drilling!
- The performance of the waste must be of sufficient size.
- The shower may only be connected downstream of a shut-off valve or sanitary fitting.

## Technical Data

Operating pressure in front of the shower fitting:	max. 1 MPa
Recommended operating pressure:	0,3 - 0,5 MPa
(1 MPa = 10 bar = 147 PSI)	
Hot water temperature:	max. 60°C
Recommended hot water temp.:	42°C
safety lock:	40°C

### **Warning: Exceeding this temperature can cause burns!**

Thermal disinfection:	max. 70°C / 4 min
Nominal voltage	100-240V AC 50-60Hz
Nominal consumption	18 W
Lights 4 x LED:	12V DC SELV 4 W
The lamp cannot be dimmed.	
Protection class	II
Protection category	IPX5

Symbol description		
	Do not use silicone containing acetic acid!	
	<b>Dimensions</b> (see page 32)	
	<b>Installation example</b> (see page 34)	
	<b>Operation</b> (see page 31)	
	<b>Spare parts</b> (see page 31)	
	<b>Service Replace illuminant</b> (see page 52)	
	<b>Cleaning</b> (see page 50) and enclosed brochure	
	<b>Electrician</b>	
	<b>Maintenance</b> (see page 53)	
	The safety device must be checked regularly according to DIN EN 1717 in accordance with national or regional regulations (at least once a year).	
	Water connection DN20	
	Warm water	
	Water connection DN20	
	Cold water	
	Shut off valve	
	Quattro 4-Way Diverter Valve	
	Trio 2-Way Diverter Valve with integrated Shut-off valve	
	Trio HighFlow	<b>Decalcifier</b> (Citric acid base)
	Thermostatic mixer HighFlow	Avoid contact with eyes and skin. If this product contacts your eyes, rinse thoroughly with water.
	The waste drain performance must be more than 50 l/min.	
	Waste	
	Raindrain	<b>Test certificate</b> (see page 54)
	Center shower tub	
	Turn on water / turn off water	

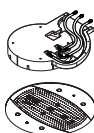

**Assembly basic kit see page 42**

**Assembly Finish set see page 47**



**Indicazioni sulla sicurezza**

- ⚠ Durante il montaggio, per pevitare ferite da schiacciamento e da taglio bisogna indossare guanti protettivi.
- ⚠ Il prodotto deve essere utilizzato esclusivamente per fare il bagno e per l'igiene del corpo.
- ⚠ I bambini e gli adulti affetti da menomazioni fisiche, psichiche e/o sensoriali devono utilizzare il sistema doccia solo sotto sorveglianza. Il prodotto non deve essere utilizzato da persone sotto l'effetto di droghe o alcolici.
- ⚠ Bisogna evitare il contatto fra il getto della doccia e parti del corpo delicate (ad es. gli occhi). Fra il soffione ed il corpo va mantenuta una distanza sufficiente.
- ⚠ Attenzione! Compensare le differenze di pressione tra i collegamenti dell'acqua fredda e dell'acqua calda.

**⚡ Allacciamento elettrico**

- ⚠ Il cablaggio deve essere eseguito esclusivamente da un installatore specializzato!
- ⚠ Preinstallare l'alimentazione della tensione 100-240 V/N/PE/50-60 Hz (Lunghezza: 0,3 m).
- ⚠ Per protezione bisogna installare un circuito di sicurezza per correnti di guasto (RCD/ FI) con una corrente differenziale nominale di ≤ 30 mA.
- ⚠ Il prodotto deve essere collegato a un collegamento equipotenziale (PA) 4 mm<sup>2</sup> presente in loco.

**⚡ Installatore elettricista**

- ⚠ I lavori di installazione e di controllo vanno eseguiti da un elettricista specializzato autorizzato, in considerazione delle norme VDE 0100 Parte 701, IEC 60364-6 e IEC 60364-7-701 nonché EN 60335-2-105.
- ⚠ Il cavo di allacciamento alla rete deve essere inserito con isolamento doppio nella presa di collegamento.

**Istruzioni per il montaggio**

- Prima del montaggio è necessario controllare che non ci siano stati danni durante il trasporto. Una volta eseguito il montaggio, non verranno riconosciuti eventuali danni di trasporto o delle superfici.

- Montare, lavare e controllare tubature e rubinetteria rispettando le norme correnti.
- Vanno rispettate le direttive di installazione nazionali vigenti nel rispettivo paese.
- Per il montaggio del prodotto da personale specializzato qualificato bisogna fare attenzione, che la superficie di fissaggio, in tutto il campo di fissaggio, sia piana (nessuna giunzione sporgente o sfalsamento di piastrella), la costruzione della parete sia adatta al montaggio del prodotto e che non presenti alcun punto debole.
- Nel praticare i fori attenzione a non danneggiare linee elettriche ed idriche!
- Lo scarico deve essere sufficientemente dimensionato.
- La doccia deve essere collegata solo a valle di una valvola d'arresto o di un'armatura sanitaria.

**Dati tecnici**

Pressione di servizio prima della rubinetteria:	max. 1 MPa
Pressione d'uso consigliata:	0,3 - 0,5 MPa
(1 MPa = 10 bar = 147 PSI)	
Temperatura dell'acqua calda:	max. 60 °C
Temp. dell'acqua calda consigliata:	42 °C
Blocco di sicurezza:	40 °C
<b>Avvertenza: il superamento di questa temperatura può causare delle ustioni!</b>	
Disinfezione termica:	max. 70 °C / 4 min
Tensione nominale	100-240V AC 50-60Hz
Assorbimento nominale	18 W
Lampade 4 x LED:	12V DC SELV 4 W
La lampadina non è dimmerabile.	
Classe di protezione	II
Tipo di protezione	IPX5

**Descrizione simbolo**

Non utilizzare silicone contenente acido acetico!	Allacciamento acqua DN20 Acqua calda	Tubo vuoto per l'alimentazione elettrica
<b>Ingombri</b> (vedi pagg. 32)	Allacciamento acqua DN20 Acqua fredda	Attenzione, superficie molto calda!
<b>Esempio di installazione</b> (vedi pagg. 34)	Rubinetto di arresto	Indossare guanti di protezione
<b>Procedura</b> (vedi pagg. 31)	Quattro Valvola a quattro vie	Indossare la protezione per gli occhi
<b>Parti di ricambio</b> (vedi pagg. 31)	Trio arresto/deviatore	<b>spugna naturale</b>
<b>Servizio Sostituzione lampada</b> (vedi pagg. 52)	Termostatico HighFlow	<b>Decalcificatore</b> (a base di acido citrico)
<b>Pulitura</b> (vedi pagg. 50) e brochure allegata	La portata di scarico deve essere superiore a 50 l/min.	Evitare il contatto con gli occhi e la pelle. Nel caso il prodotto penetra negli occhi, sciacquarlo accuratamente con acqua.
<b>Installatore elettricista</b>	Scarico	Corrente ON / OFF
<b>Manutenzione</b> (vedi pagg. 53)	Raindrain	<b>Segno di verifica</b> (vedi pagg. 54)
La valvola di non ritorno deve essere controllata regolarmente come da DIN EN 1717, secondo le normative nazionali e regionali (almeno una volta all'anno).	Centro piatto doccia	
	Aprire l'acqua / Chiudere l'acqua	

**Montaggio corpo base vedi pagg. 42**

**Montaggio Set esterno vedi pagg. 47**



## Indicaciones de seguridad

- ⚠ Durante el montaje deben utilizarse guantes para evitar heridas por aplastamiento o corte.
- ⚠ El producto solo debe ser utilizado para fines de baño, higiene y limpieza corporal.
- ⚠ Niños, así como adultos con limitaciones corporales, mentales y/o sensoriales no deben utilizar el sistema de duchas sin vigilancia. Personas que se encuentran bajo el efecto de alcohol o drogas, no deben utilizar el sistema de duchas.
- ⚠ Debe evitarse el contacto del chorro del pulverizador con partes sensibles del cuerpo (por ej. ojos). Debe mantenerse una distancia suficiente entre pulverizador y cuerpo.
- ⚠ Grandes diferencias de presión en servicio entre agua fría y agua caliente deben equilibrarse.

### Conexión eléctrica

- ⚠ ¡Solo un especialista está autorizado para llevar a cabo los trabajos de cableado!
- ⚠ Instalar previamente la alimentación de tensión 100-240V/N/PE/50-60Hz (longitud: 0,3 m).
- ⚠ La conexión debe establecerse a través de un dispositivo de protección de corriente residual (RCD/ FI) con un interruptor diferencial de corriente ≤ 30 mA.
- ⚠ El producto tiene que ser conectado a una conexión equipotencial (PA) de 4 mm<sup>2</sup> de puesta a disposición en obra.

### Instalador eléctrico

- ⚠ La instalación y las pruebas solo pueden ser realizadas por técnicos electricistas cualificados, respetando las reglamentaciones de las normas VDE 0100, parte 701, IEC 60364-6 y IEC 60364-7-701, así como la norma EN 60335-2-105.
- ⚠ El cable de conexión a la red tiene que ser conectado en la toma con aislamiento doble .

## Indicaciones para el montaje

- Antes del montaje se debe examinar el producto contra daños de transporte. Después de la instalación no se reconoce ningún daño de transporte o de

superficie.

- Los conductos y la grifería deben montarse, lavarse y comprobarse según las normas vigentes.
- Es obligatorio el cumplimiento de las directrices de instalación vigentes en el país respectivo.
- Durante el montaje del producto, mediante personal especializado, se debe asegurar de que la superficie de sujeción en todo el área de la fijación sea plana (sin fugas o azulejos que sobresalgan), que la estructura del muro sea adecuada para el montaje del producto y que no presente puntos débiles.
- ¡Prestar especial atención al taladrar cerca de conductos eléctricos o de agua!
- La tubería de desagüe ha de tener una dimensión suficiente.
- La roseta de ducha debe conectarse siempre a una válvula de bloqueo o a valvulería sanitaria.

## Datos técnicos

Presión de servicio delante de la grifería:	max. 1 MPa
Presión recomendada en servicio:	0,3 - 0,5 MPa
(1 MPa = 10 bar = 147 PSI)	
Temperatura del agua caliente:	max. 60 °C
Temp. recomendada del agua caliente:	42 °C
Bloqueo de seguridad:	40 °C
<b>Aviso de peligro: si se supera esta temperatura pueden provocarse quemaduras.</b>	
Desinfección térmica:	max. 70 °C / 4 min
Tensión nominal	100-240V AC 50-60Hz
Consumo nominal	18 W
Lámparas 4 x LED:	12V DC SELV 4 W
La lámpara no es regulable.	
Clase de protección	II
Tipo de protección	IPX5

## Descripción de símbolos

	No utilizar silicona que contiene ácido acético!		Conexión de agua DN20		Tubo vacío para alimentación eléctrica
	<b>Dimensiones</b> (ver página 32)		Agua caliente		¡Atención, superficie muy caliente!
	<b>Ejemplos de montaje</b> (ver página 34)		Conexión de agua DN20		Protección obligatoria de la vista
	<b>Manejo</b> (ver página 31)		Agua fría		Protección obligatoria de las manos
	<b>Repuestos</b> (ver página 31)		Llave de paso		Protección obligatoria de las manos
	<b>Reparación Cambio de luminarias</b> (ver página 52)		Quattro válvula de 4 vías		<b>Esponja natural</b>
	<b>Limpiar</b> (ver página 50) y folleto anexo		Trio llave de paso y distribuidor		<b>Descalcificador</b> (a base de ácido cítrico)
	<b>Instalador eléctrico</b>		Termostato HighFlow		Evitar el contacto con ojos y piel. En caso de que el producto entre en contacto con los ojos, debe lavarlos muy bien con agua.
	<b>Mantenimiento</b> (ver página 53)		El caudal de desagüe debe ser como mínimo de 50 l/min		Corriente on / off
	Las válvulas anti-retorno tienen que ser controladas regularmente según la norma DIN EN 1717, en acuerdo con las regulaciones nacionales o regionales (una vez al año, por lo menos).		Desagüe		<b>Marca de verificación</b> (ver página 54)
			Raindrain		
			X		
			Abrir el agua / Cerrar el agua		



### Montaje Kit base ver página 42



### Montaje Embellecedor exterior ver página 47



## Veiligheidsinstructies

- ⚠ Bij de montage moeten ter voorkoming van knel- en snijwonden handschoenen worden gedragen.
- ⚠ Het product mag alleen voor het wassen, hygiënische doeleinden en voor de lichaamsreiniging worden gebruikt.
- ⚠ Kinderen en volwassenen met lichamelijke, geestelijke en/of sensorische beperkingen mogen het douchesysteem niet zonder toezicht gebruiken. Personen onder invloed van alcohol of drugs mogen het douchesysteem niet gebruiken.
- ⚠ Het contact van de douchestraal met gevoelige lichaamsdelen (bijv. ogen) moet worden voorkomen. Er moet voldoende afstand tussen douche en lichaam aangehouden worden.
- ⚠ Grote drukverschillen tussen de koud- en warmwatertoevoer dienen vermeden te worden.

### Elektrische aansluiting

- ⚠ De elektrische aansluiting mag alleen door een vakman worden uitgevoerd!
- ⚠ Spanningsvoorziening 100-240V/N/PE/50-60Hz (lengte: 0,3 m) vooraf installeren.
- ⚠ Deze moet middels een 2-polige FI-schakelaar met 30mA afgezekerd worden.
- ⚠ Het product moet aangesloten worden aan een potentiaalvereffening van het gebouw (PA) van 4 mm<sup>2</sup>.

### Electro-installateur

- ⚠ De installatie- en controlewerkzaamheden moeten uitgevoerd worden door een geautoriseerde elektricien die rekening houdt met de normen VDE 0100 Deel 701, IEC 60364-6, IEC 60364-7-701 en EN 60335-2-105.
- ⚠ Het netsnoer moet dubbel geïsoleerd in de contactd os geleid worden.

## Montage-instructies

- Vóór de montage moet het product gecontroleerd worden op transportschade. Na de inbouw wordt geen transport- of oppervlakteschade meer aanvaard.
- De leidingen en armaturen moeten gemonteerd, gespoeld en gecontroleerd worden volgens de geldige normen.
- De in de overeenkomstige landen geldende installatierichtlijnen moeten nageleefd worden.

- Bij de montage van het product door gekwalificeerd vakpersoneel moet erop gelet worden dat het montagevlak in het volledige bereik van de bevestiging vlak is (geen uitstekende voegen of verspringende tegels), dat de wand geschikt is voor de montage van het product en geen zwakke plaatsen vertoont.
- Bij het boren in stroom- en waterleidingen
- De afvoercapaciteit moet voldoende gedimensioneerd worden.
- De douche mag enkel aangesloten worden na een afsluitklep of een sanitaire kraan.

## Technische gegevens

Stroomdruk voor de kraan:	max. 1 MPa
Aanbevolen werkdruk:	0,3 - 0,5 MPa
(1 MPa = 10 bar = 147 PSI)	
Temperatuur warm water:	max. 60 °C
Aanbevolen warm water temp.:	42 °C
Veiligheidsmechanisme:	40 °C
<b>Waarschuwing: Een overschrijding van die temperatuur kan brandwonden veroorzaken!</b>	
Thermische desinfectie:	max. 70 °C / 4 min
Nominale spanning	100-240V AC 50-60Hz
Opgenomen vermogen	18 W
Lampjes 4 x LED:	12V DC SELV 4 W
De lamp is niet dimbaar.	
Beschermingsklasse	II
Beveiligingsklasse	IPX5

## Symbolbeschrijving

Gebruik geen zuurhoudende silicone!	Wateraansluiting DN20	Loze leiding voor stroom toevoer
<b>Maten</b> (zie blz. 32)	Warm water	Let op: heet!
<b>Montagevoorbeelden</b> (zie blz. 34)	Wateraansluiting DN20	Veiligheidshandschoenen verplicht
<b>Bediening</b> (zie blz. 31)	Inbouwstopkraan	Oogbescherming verplicht
<b>Service onderdelen</b> (zie blz. 31)	Quattro 4-weg omstelkraan	<b>Natuurzwam</b>
<b>Service Verlichting vervangen</b> (zie blz. 52)	Trio stop- en omstelkraan	<b>Ontkalker</b> (citroenzuurbasis)
<b>Reinigen</b> (zie blz. 50) en bijgevoegde brochure	Thermostaat HighFlow	Contact met huid en ogen vermijden. Indien het product in de ogen terecht komt, moet het grondig met water uitgespoeld worden.
<b>Electro-installateur</b>	De afvoercapaciteit moet meer dan 50 l/min bedragen.	Stroom aan / uit
<b>Onderhoud</b> (zie blz. 53)	Afvoer	<b>Keurmerk</b> (zie blz. 54)
Keerkleppen moeten volgens DIN EN 1717 regelmatig en volgens plaatselijk geldende eisen op het functioneren gecontroleerd worden. (Tenminste een keer per jaar)	<b>Raindrain</b>	
	Midden Douchebak	
	Hoofdkraan openen / Water afsluiten	

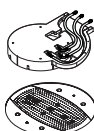

**Montage Basisset zie blz. 42**

**Montage Kleurset zie blz. 47**



## Sikkerhedsanvisninger

- ⚠ Ved monteringen skal der bruges handsker for at undgå kvæstelser og snitsår.
- ⚠ Produktet må kun bruges til bade-, hygiejne og kropsrengøringsformål.
- ⚠ Børn som også voksne med fysiske, mentale og / eller sensoriske begrænsninger må ikke bruge brusersystemet uden opsyn. Personer som er under indflydelse af alkohol eller narkotika må ikke bruge brusersystemet.
- ⚠ Bruserstrålens kontakt med sensitive områder (f.eks. øjne) skal undgås. Der skal være en tilstrækkelig afstand mellem bruseren og kroppen.
- ⚠ Større trykforskelle mellem koldt og varmt vand bør udjævnes.

### El-tilslutning

- ⚠ Ledningsarbejde må kun foretages af en fagmand!
- ⚠ Forinstallér spændingsforsyning 100-240V/N/PE/50-60Hz (længde: 0,3 m).
- ⚠ Sikringen skal køre over en fejlstrømssikring (HFI) med en fejlstrømsdifference ≤ 30 mA.
- ⚠ Produktet skal tilsluttes til en potentialudligning (PA) 4 mm<sup>2</sup>.

### El-installatør

- ⚠ Installeringen og afprøvningen skal gennemføres af en godkendt el-installatør iht. VDE 0100 part 701, IEC 60364-6 og IEC 60364-7-701 samt EN 60335-2-105.
- ⚠ Nettildslutningsledningen skal føres dobbeltisoleret ind i tilslutningsdåsen.

## Monteringsanvisninger

- Før monteringen skal produktet kontrolleres for transportskader. Efter monteringen godkendes transportskader eller skader på overfladen ikke længere.
- Ledningerne og armaturerne skal monteres, skylles og kontrolleres iht. de gældende standarder.
- Installationsbestemmelserne, der gælder i det enkelte land, skal overholdes.
- Ved montering af produktet igennem kvalificerede fagfolk skal der holdes øje med, at fastgørelsesoverfladen er plan i alle områder hvor produktet monteres (ingen fremragende fuger eller fliseforskydninger), at væggene er velegnet til monteringen af produktet og ikke har svare områder.
- Pas på strøm- og vandledninger ved boring!

- Afløbet skal være i en tilstrækkelig størrelse.
- Bruseren må kun tilsluttes efter en afspærringsventil eller et sanitæramatur.

## Tekniske data

Betjeningstryk før armaturet:	max. 1 MPa
Anbefalet driftstryk:	0,3 - 0,5 MPa
(1 MPa = 10 bar = 147 PSI)	
Varmtvandstemperatur:	max. 60°C
Anbefalet varmtvandstemperatur:	42°C
Sikkerhedsspærre:	40°C
<b>Advarsel: Hvis temperaturen overskrides kan det føre til forbrændinger!</b>	
Termisk desinfektion:	max. 70°C / 4 min
Mærkespænding	100-240V AC 50-60Hz
Nominelt forbrug	18 W
Lamper 4 x LED:	12V DC SELV 4 W
Lyskilden kan ikke dæmpes.	
Beskyttelsesklasse	II
Kapslingsklasse	IPX5

## Symbolbeskrivelse

	Der må ikke benyttes eddikesyreholdig silikone!		Vandtilslutning DN20		Tomrør til strømforsyning
	<b>Målene</b> (se s. 32)		Varmt vand		Varm overflade!
	<b>Monteringseksempler</b> (se s. 34)		Vandtilslutning DN20		Beskyttelseshandsker påbudt
	<b>Brugsanvisning</b> (se s. 31)		Kold vand		Øjenværn påbudt
	<b>Reserve dele</b> (se s. 31)		Afspæringsventil		<b>Natursvamp</b>
	<b>Service Udskifte lyskilden</b> (se s. 52)		Quattro 4-vejs ventil		<b>Afkalkningsmiddel</b> (citronsyre-basis)
	<b>Rengøring</b> (se s. 50) og vedlagt brochure		Trio afspæringsventil og omskifter		Undgå kontakt med øjne og huden. Skyl grundigt med vand, hvis produktet kommer i øjnene.
	<b>El-installatør</b>		Trio High Flow		Strøm til / fra
	<b>Service</b> (se s. 53)		Termostat HighFlow		<b>Godkendelse</b> (se s. 54)
	Ifølge DIN EN 1717 skal gennemstrømningsbegrænsere i overensstemmelse med nationale regler afprøves regelmæssigt (mindst en gang om året).		Afløbskapaciteten skal være mere end 50 l/min.		
			Afløb		
			Raindrain		
			Midt brusekar		
			Tænd for vandet / Luk for vandet		

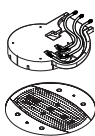

**Montering Basis-sæt se s. 42**

**Montering Kappesæt se s. 47**





**Avisos de segurança**

- ⚠ Durante a montagem devem ser utilizadas luvas de protecção, de modo a evitar ferimentos resultantes de entalamentos e de cortes.
- ⚠ O produto só pode ser utilizado para fins de higiene pessoal.
- ⚠ Crianças e adultos com deficiências motoras, mentais e/ou sensoriais não podem utilizar o sistema de duche sem monitorização. Pessoas que estejam sob a influência de álcool ou drogas não podem utilizar o sistema de duche.
- ⚠ Deve-se evitar o contacto dos jactos de água com partes do corpo sensíveis (p. ex. olhos). É necessário manter uma distância suficiente entre o chuveiro e o corpo.
- ⚠ Grandes diferenças entre as pressões das águas quente e fria devem ser compensadas.

**⚡ Ligação eléctrica**

- ⚠ A instalação eléctrica deve ser efectuada apenas por um electricista qualificado!
- ⚠ Pré-instalar a alimentação eléctrica 100-240V/N/PE/50-60Hz (comprimento: 0,3 m).
- ⚠ A ligação deve estar protegida por um diferencial magneto-térmico bipolar (RRCB) com uma corrente residual ≤ 30 mA.
- ⚠ O produto deve ser conectado a uma ligação equipotencial (PA) 4 mm<sup>2</sup> existente.

**⚡ Electricista de construção civil**

- ⚠ Os trabalhos de instalação e de controlo devem ser efetuados por um técnico electricista devidamente autorizado e especializado, tendo em consideração as normas VDE 0100 Parte 701, IEC 60364-6 e IEC 60364-7-701, bem como EN 60335-2-105.
- ⚠ O cabo de alimentação eléctrica deve ser inserido na t mada de ligação com um isolamento duplo.

**Avisos de montagem**

- Antes da montagem deve-se controlar o produto relativamente a danos de transporte. Após a montagem não são aceites quaisquer danos de transporte ou de superfície.

- As tubagens e a torneira têm que ser montadas, enxaguadas e verificadas de acordo com as normas em vigor.
- A prescrições de instalação válidas nos respetivos países devem ser respeitadas.
- Durante a montagem efectuada por técnicos qualificados deve ter-se em atenção que a superfície de fixação seja plana em toda a sua extensão (sem juntas ou ladrilhos salientes), que a estrutura da parede seja adequada para a montagem do produto e que não apresente pontos fracos.
- Ter atenção a instalações eléctricas e de água durante os trabalhos de perfuração!
- A capacidade de escoamento deve ser devidamente dimensionada.
- O chuveiro só pode ser instalado a seguir a uma válvula de retenção ou valvularia de sanitários.

**Dados Técnicos**

Pressão de funcionamento anterior à misturadora:	max. 1 MPa
Pressão de func. recomendada:	0,3 - 0,5 MPa
(1 MPa = 10 bar = 147 PSI)	
Temperatura da água quente:	max. 60 °C
Temp. água quente recomendada:	42 °C
Bloqueio de segurança:	40 °C
<b>Aviso de advertência: Exceder esta temperatura pode causar queimaduras!</b>	
Desinfecção térmica:	max. 70 °C / 4 min
Tensão nominal	100-240V AC 50-60Hz
Consumo nominal	18 W
Lâmpadas 4 x LED:	12V DC SELV 4 W
A lâmpada não é regulável.	
Classe de protecção	II
Tipo de protecção	IPX5

**Descrição do símbolo**

	Não utilizar silicone que contenha ácido acético!		Ligação da água DN20		Tubo VD para alimentação eléctrica
	<b>Medidas</b> (ver página 32)		Água quente		Superfície quente!
	<b>Exemplos de montagem</b> (ver página 34)		Ligação da água DN20		Protecção obrigatória das mãos
	<b>Funcionamento</b> (ver página 31)		Água fria		Protecção obrigatória dos olhos
	<b>Peças de substituição</b> (ver página 31)		Torneira de passagem		<b>Esponja natural</b>
	<b>Manutenção Substituir lâmpada</b> (ver página 52)		Quatro válvula de diversão de 4 vias		<b>Descalcificador</b> (À base de ácido cítrico)
	<b>Limpeza</b> (ver página 50) e brochura em anexo		Trio universal inversor/válvula de corte		Evitar contacto com os olhos e pele. Se o produto entrar em contacto com os olhos deve lavar abundantemente com água.
	<b>Electricista de construção civil</b>		Trio		Electricidade ligada/desligada
	<b>Manutenção</b> (ver página 53)		Trio universal inversor/válvula de corte		<b>Marca de controlo</b> (ver página 54)
	As válvulas anti-retorno devem ser verificadas regularmente de acordo com a DIN EN 1717 segundo os regulamentos nacionais ou regionais (pelo menos uma vez por ano).		Misturadora termostática HighFlow		
			Capacidade de escoamento tem que ser superior a 50 l/min.		
			Escoamento		
			Meio da base de duche		
			Abrir a água / Cortar a água		

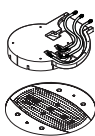

**Montagem Corpo base ver página 42**

**Montagem Conjunto completo ver página 47**



### Wskazówki bezpieczeństwa

- ⚠ Aby uniknąć zranień na skutek zgniecenia lub przecięcia, podczas montażu należy nosić rękawice ochronne.
- ⚠ Produkt może być używany tylko do kąpieli, higieny i czyszczenia ciała.
- ⚠ Zarówno dzieci, jak i dorośli z fizycznymi, psychicznymi i/lub sensorycznymi ograniczeniami nie mogą korzystać z prysznica bez opieki. Osoby znajdujące się pod wpływem alkoholu lub narkotyków nie mogą korzystać z prysznica.
- ⚠ Należy unikać kontaktu strumienia wypływającego z głowicy z wrażliwymi częściami ciała (np. oczami). Należy zachowywać odpowiednią odległość pomiędzy głowicą a ciałem.
- ⚠ Znaczne różnice ciśnień na dopływach ciepłej i zimnej wody muszą zostać wyrównane.

### ⚡ Przyłącze elektryczne

- ⚠ Podłączenie elementów elektrycznych może być przeprowadzone jedynie przez fachowca elektryka!
- ⚠ Zainstalować zasilanie napięciowe 100-240 V/N/PE/50-60 Hz (Długość: 0,3 m).
- ⚠ Zabezpieczenie instalacji musi mieć miejsce przy użyciu zabezpieczenia różnicowego (RCD/ FI) z różnicą pomiarów wynoszącą ≤ 30 mA.
- ⚠ Produkt należy podłączyć do ekwipotencjalizacji (PA) 4 mm<sup>2</sup> udostępnionej przez klienta.

### ⚡ Elektryk instalator

- ⚠ Prace instalacyjne i kontrolne mogą być przeprowadzane jedynie przez wykwalifikowanego elektryka, przestrzegając przepisów z VDE 0100 część 701, IEC 60364-6 i IEC 60364-7-701 oraz EN 60335-2-105.
- ⚠ Przewód sieciowy musi być wyposażony w podwójną izolację i wprowadzony do puszkii przyłączeniowej.

### Wskazówki montażowe





























- Przed montażem należy skontrolować produkt pod kątem szkód transportowych. Po montażu nie widać żadnych szkód transportowych ani szkód na powierzchni.
- Przewody i armatura muszą być montowane, płukane i kontrolowane według obowiązujących norm.

- Należy przestrzegać wytycznych instalacyjnych obowiązujących w danym kraju.
- Montaż produktu musi być wykonany przez wykwalifikowanego fachowca. Powierzchnia w miejscu montażu musi być równa (bez uskoków wzgl. wzajemnie przesuniętych płytek). Ściana w miejscu montażu musi być stabilna. Dołożone w komplecie śruby i kołki rozporowe są przeznaczone do betonu.
- Podczas wiercenia uważać na instalacje elektryczne i wodne!
- Odptyw musi mieć wystarczającą wydajność.
- Prysznic można podłączyć tylko po użyciu zaworu odcinającego lub armatury sanitarnej.

### Dane techniczne

Ciśnienie robocze przed armaturą:	maks. 1 MPa
Zalecane ciśnienie robocze:	0,3 - 0,5 MPa
(1 MPa = 10 bary = 147 PSI)	
Temperatura wody gorącej:	maks. 60 °C
Zalecana temperatura wody gorącej:	42 °C
Blokada bezpieczeństwa:	40 °C
<b>Wskazówka ostrzegawcza: Przekroczenie tej temperatury może prowadzić do oparzeń!</b>	
Dezynfekcja termiczna:	maks. 70 °C / 4 min
Napięcie znamionowe	100-240V AC 50-60Hz
Nominalny pobór mocy	18 W
Lampy 4 x LED:	12V DC SELV 4 W
Żarówki nie można ściemnić.	
Klasa ochrony	II
Stopień ochrony	IPX5

## Opis symbolu

	Nie stosować silikonów zawierających kwas octowy!		Podłączenie wody DN20		Rurka kablowa na doprowadzenie instalacji elektrycznej
	<b>Wymiary</b> (patrz strona 32)		Ciepła woda		Uwaga na gorącą powierzchnię!
	<b>Przykłady montażowe</b> (patrz strona 34)		Podłączenie wody DN20		Nosić rękawice ochronne
	<b>Obsługa</b> (patrz strona 31)		Zimna woda		Nosić okulary ochronne
	<b>Części serwisowe</b> (patrz strona 31)		Zawór podtynkowy		<b>Gąbka naturalna</b>
	<b>Serwisowy Wymienić żarówki</b> (patrz strona 52)		Regulator czterodrożny Quattro		<b>Środek odkamieniający</b> (na bazie kwasu cytrynowego)
	<b>Czyszczenie</b> (patrz strona 50) i dołączona broszura		Zawór odcinający i regulacyjny Trio Universal		Unikać kontaktu z oczami i skórą. Jeżeli produkt dostanie się do oczu, należy je gruntownie wypłukać wodą.
	<b>Elektryk instalator</b>		Termostat HighFlow		Wł. / wyl. prąd
	<b>Konserwacja</b> (patrz strona 53)		Wydajność odpływu musi być wyższa niż 50 l/min.		<b>Znak jakości</b> (patrz strona 54)
	Zawory zwrotne muszą być, według normy DIN EN 1717 na regionalnych warunkach, kontrolowane (przynajmniej raz w roku).		Odptyw		
			Środek brodzika		
			Otworzyć wodę / Zakręcić wodę		

 **Montaż Zestaw podstawowy patrz strona 42**

 **Montaż Elementy zewnętrzne patrz strona 47**



## Bezpečnostní pokyny

- ⚠ Pro zabránění řezným zraněním a pohmožděninám je nutné při montáži nosit rukavice.
- ⚠ Produkt smí být používán pouze ke koupání a za účelem tělesné hygieny.
- ⚠ Děti a dospělí osoby s tělesným, duševním a / nebo smyslovým postižením nesmí produkt používat bez dozoru. Osoby pod vlivem alkoholu nebo drog nesmí produkt používat.
- ⚠ Je nutné zabránit kontaktu vodních paprsků sprchy s měkkými částmi těla (např. očima). Je nutné dodržovat dostatečný odstup mezi sprchou a tělem.
- ⚠ Je nutné vyrovnat velké rozdíly tlaku mezi přípoji studené a teplé vody.

### Elektrické připojení

- ⚠ Elektroinstalace smí být provedena jen kvalifikovaným elektrikářem!
- ⚠ Zdroj napětí 100-240V/N/PE/50-60Hz (délka: 0,3 m) předinstalovat.
- ⚠ Přívod musí být chráněn proudovým chráničem pro chybový proud (RCD/ FI) s mírným rozdílovým proudem  $\leq 30$  mA.
- ⚠ Produkt musí být připojen k vyrovnání potenciálu (PA) 4 mm<sup>2</sup> nainstalovanému provozovatelem.

### Elektroinstalatér

- ⚠ Instalační práce a přezkoušení musí být provedeno autorizovaným elektrotechnickým odborníkem za zohlednění směrnic VDE 0100, část 701, IEC 60364-6 a IEC 60364-7-701 a také EN 60335-2-105.
- ⚠ Připojovací síťové vedení musí být zavedeno do krabic přípojky tak, aby bylo dvojitě odizolované .

## Pokyny k montáži

- Před montáží je třeba produkt zkontrolovat, zda nebyl při transportu poškozen. Po zabudování nebudou uznány žádné škody způsobené transportem nebo poškození povrchu.
- Vedení a armatura musí být namontovány, propláchnuty a otestovány podle platných norem.
- Je třeba dodržovat montážní pravidla platné v dané zemi.
- Při montáži produktu kvalifikovanou osobou je třeba dbát na to, aby byla upevňovací plocha v celé oblasti upevnění rovná (žádné vyčnívající spáry nebo

zapuštění obkladů), aby struktura stěny byla vhodná pro montáž produktu a neměla žádná slabá místa.

- Při vrtání dejte pozor na elektrická vedení a vodovodní potrubí!
- Propustnost odpadu musí být dostatečně dimenzována.
- Sprcha smí být připojena pouze za uzavíracím ventilem nebo sanitární armaturou.

## Technické údaje

Provozní tlak před armaturou:	max. 1 MPa
Doporučený provozní tlak: (1 MPa = 10 bar = 147 PSI)	0,3 - 0,5 MPa
Teplota horké vody:	max. 60 °C
Doporučená teplota horké vody:	42 °C
Bezpečnostní zámeček:	40 °C
<b>Varování: Překročení této teploty může vést k popáleninám!</b>	
Teplná desinfekce:	max. 70 °C / 4 min
Nízké napětí	100-240V AC 50-60Hz
Jmenovitý proud	18 W
Svítilidla 4 x LED:	12V DC SELV 4 W
Světlo není regulovatelné.	
Třída ochrany	II
Třída krytí	IPX5

## Popis symbolů

	Nepoužívat silikon s obsahem kyseliny octové!		Připojení vody DN20		Instalační trubka pro napájení elektrickým proudem
	<b>Rozměry</b> (viz strana 32)		Teplá voda		Pozor, horký povrch!
	<b>Příklady montáže</b> (viz strana 34)		Připojení vody DN20		Noste ochranné rukavice
	<b>Ovládání</b> (viz strana 31)		Studená voda		Noste ochranné brýle
	<b>Servisní díly</b> (viz strana 31)		Podomítkový uzavírací ventil		<b>Přírodní mořská houba</b>
	<b>Servisní Výměna svítidel</b> (viz strana 52)		Quattro čtyřcestné přestavování		<b>Odvápňovač</b> (báze kyseliny citrónové)
	<b>Čištění</b> (viz strana 50) a příložená brožura		Trio Universal - Uzavírací a přepínací ventil		Zabraňte styku s pokožkou a očima. Zasáhne-li výrobek oči, důkladně je vypláchněte vodou.
	<b>Elektroinstalatér</b>		Trio High Flow		Elektrický proud ZAP / VYP
	<b>Údržba</b> (viz strana 53)		Termostat HighFlow		<b>Zkušební značka</b> (viz strana 54)
	Bezpečnostní zařízení musí být podle DIN EN 1717 pravidelně v souladu s národními nebo místními předpisy (DIN 1988) jednou ročně přezkoušena.		Odtokový výkon musí být vyšší než 50 l/min.		
			Odtok		
			<b>Raindrain X</b>		
			Střed sprchové vany		
			Vodu zapojit / Vodu odpojit		

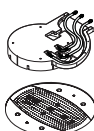

**Montáž základní souprava viz strana 42**

**Montáž Vrchní sada viz strana 47**



## Bezpečnostné pokyny

- ⚠ Pri montáži musíte nosiť rukavice, aby ste predišli pomliaždeninám a rezným poraneniam.
- ⚠ Produkt sa smie používať len na kúpanie a telesnú hygienu.
- ⚠ Produkt nesmú bez dozoru používať deti, ako aj dospelé osoby s telesným, duševným a/alebo zmyslovým postihnutím. Produkt nesmú používať ani osoby, ktoré sú pod vplyvom alkoholu alebo drog.
- ⚠ Vyhnite sa kontaktu vodného lúča sprchy s citlivými miestami tela (napr. oči). Dodržiavajte dostatočnú vzdialenosť medzi sprchou a telom.
- ⚠ Veľké rozdiely v tlaku medzi prípojkami studenej a teplej vody musia byť vyrovnané.

### Elektrické pripojenie

- ⚠ Elektroinštalácia môže byť vykonaná len kvalifikovaným elektrikárom!
- ⚠ Predinštalujte napájanie napätím 100-240 V/N/PE/50-60 Hz (dĺžka: 0,3 m).
- ⚠ Prívod musí byť chránený prúdovým chráničom (RCD/FI) pre chybový prúd s merným rozdielovým prúdom  $\leq 30$  mA.
- ⚠ Výrobok sa musí pripojiť na vyrovnanie potenciálov (PA) 4 mm<sup>2</sup> prítomné zo strany stavby.

### Elektroinštalatér

- ⚠ Inštalácia a skúšobné práce musí vykonávať len autorizovaný elektrikár pri zohľadnení noriem VDE 0100 časť 701, IEC 60364-6 a IEC 60364-7-701, ako aj EN 60335-2-105.
- ⚠ Sieťové prípojné vedenie sa musí viesť do prípojnej kábelnice s dvojitou izoláciou

## Pokyny pre montáž

- Pred montážou musíte produkt skontrolovať, či nebol počas transportu poškodený. Po zabudovaní nebudú uznané žiadne škody spôsobené transportom alebo poškodenia povrchu.
- Ledningarna och blandaren måste monteras, spolás igenom och kontrolleras enligt de gällande normerna.
- Je potrebné dodržiavať smernice o inštalácii, ktoré sú práve teraz platné v krajinách.

- Pri montáži produktu kvalifikovanou osobou treba dávať pozor na to, aby bola upevňovacia plocha v celej oblasti upevnenia rovná (žiadne vyčnievajúce medzery alebo zapustenia obkladov), aby štruktúra steny bola vhodná pre montáž produktu a nemá žiadne slabé miesta.
- Pri vŕtaní dajte pozor na elektrické vedenia a vodovodné potrubia!
- Pripustnosť odpadu musí byť dostatočne dimenzovaná.
- Sprchu je možné napojiť len na uzatvárací ventil alebo na sanitárnu armatúru.

## Technické údaje

Prevádzkový tlak pred armatúrou:	max. 1 MPa
Doporučený prevádzkový tlak: (1 MPa = 10 bar = 147 PSI)	0,3 - 0,5 MPa
Teplota teplej vody:	max. 60 °C
Doporučená teplota teplej vody:	42 °C
Bezpečnostný zámok:	40 °C
<b>Varovanie: Prekročenie tejto teploty môže viesť k popáleninám!</b>	
Termická dezinfekcia:	max. 70 °C / 4 min
Menovité napätie	100-240V AC 50-60Hz
Menovitý príkon	18 W
Svietidlá 4 x LED:	12V DC SELV 4 W
Osvetľovací prostriedok je stmievateľný.	
Trieda ochrany	II
Trieda ochrany	IPX5

## Popis symbolov

	Nepoužívať silikón s obsahom kyseliny octovej!		Pripojenie vody DN20		Inštalčná rúrka elektrického napájania
	<b>Rozmery</b> (viď strana 32)		Teplá voda		Pozor, horúci vzduch!
	<b>Príklady montáže</b> (viď strana 34)		Pripojenie vody DN20		Noste ochranné rukavice
	<b>Obsluha</b> (viď strana 31)		Studená voda		Noste ochranné okuliare
	<b>Servisné diely</b> (viď strana 31)		Podmietský uzatvárací ventil		<b>Prírodná morská huba</b>
	<b>Servisná Výmena svietidiel</b> (viď strana 52)		Quattro štvorcestné prestavenie		<b>Odvápňovač</b> (báza kyseliny citrónovej)
	<b>Čistenie</b> (viď strana 50) a priložená brožúra		Trio univerzálny uzatvárací a nastavovací ventil		Zabrňte styku s pokožkou a očami. Ak produkt zasiahne oči, dôkladne ich vypláchnite vodou.
	<b>Elektroinštalatér</b>		Trio HighFlow		Výkon odtoku musí byť vyšší ako 50 l/min.
	<b>Údržba</b> (viď strana 53)		HighFlow		Odtok
	Bezpečnostné zariadenie musí byť podľa DIN EN 1717 pravidelne raz za rok preskúšané v súlade s národnými alebo miestnymi predpismi (DIN 1988).		Raindrain		Stred sprchovej vane
			X		Zap./vyp. prúd
					<b>Osvedčenie o skúške</b> (viď strana 54)

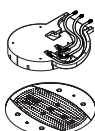

**Montáž základná súprava viď strana 42**



**Montáž Vrchná sada viď strana 47**



**安全技巧**

- △ 装配时为避免挤压和切割受伤，必须戴上手套。
- △ 本产品只允许作为洗浴、卫生和洁身之用。
- △ 不得让儿童和肢体、精神和/或意识有障碍的成人在不受监管的情况下使用淋浴系统。受酒精或毒品影响的人员不得使用淋浴系统。
- △ 必须避免让身体敏感部位（如眼睛）接触到莲蓬头喷水。必须保持莲蓬头与人头之间有足够的安全距离。
- △ 冷热水管间过大的压力差必须予以平衡。

**电气连接**

- △ 电气接口只能由电气专业人员进行操作！
- △ 预安装电源电压 100-240V/N/PE/50-60Hz（长度：0.3 m）。
- △ 保险装置必须是额定电流 ≤ 30 mA的故障电流保护装置。
- △ 产品必须连接施工方现有的电位补偿(PA) 4 mm。

**电气安装人员**

- △ 安装和检查工作由有资质的电气专业人员按照德国电气工程协会VDE 0100标准中第701项和国际电工委员会 IEC 60364-6项和国际电工委员会 IEC 60364-7-701标准以及欧洲标准60335-2-105执行。
- △ 必须使电源线双重绝缘  并插入接线盒。

**安装提示**

- 安装前必须检查产品是否受到运输损害。安装后将不认可运输损害或表面损伤。
- 管道和阀门必须根据通用标准进行安装、冲洗和检查。
- 请遵守当地国家现行的安装规定。
- 由有资格的专业人员进行产品安装时请注意：在所有加固区域中，加固表面是否平整（无突出的接缝或瓷砖），墙体结构是否适合产品安装且未显露出任何缺点。
- 钻孔时请注意电线和水管！
- 废水管的性能必须具有充足的尺寸。
- 该花洒仅允许连接在卫浴龙头或截止阀之后。

**技术参数**

花洒接头前方的操作压力：  
 推荐工作压力：  
 (1 MPa = 10 bar = 147 PSI)  
 热水温度：  
 推荐热水温度：  
 安全止动器：  
**警告：温度过高会引发燃烧危险！**  
 热力消毒：  
 额定电压  
 额定输入  
 灯 4 x LED：  
 灯具不可调光。  
 保护等级  
 保护等级

最大 1 MPa  
 0,3 - 0,5 MPa  
 最大 60°C  
 42°C  
 40°C  
 最大 70°C / 4 分钟  
 100-240V AC 50-60Hz  
 18 W  
 12V DC SELV 4 W  
 II  
 IPX5

**符号说明**

	请勿使用含有乙酸的硅胶！		水连接 DN20		电源线布线导管
	大小 (参见第页 32)		热水		热表面！
	安装示意 (参见第页 34)		水连接 DN20		配戴保护手套
	操作 (参见第页 31)		冷水		配戴护眼用具
	备用零件 (参见第页 31)		截止阀		天然海绵
	备用零 更换灯具 (参见第页 52)		Quattro 四通转换器		柔软剂 (柠檬酸)
	清洗 (参见第页 50) 并附有小手册		通用的三通截止阀和换向阀		避免眼睛和皮肤接触。如该产品不慎进入眼睛，立即用清水彻底冲洗。
	电气安装人员		Trio HighFlow 恒温龙头 HighFlow		电流 接通/断开
	保养 (参见第页 53)		排水功率必须大于 50 l/min.		检验标记 (参见第页 54)
	必须根据DIN EN 1717要求并根据国家或地方规定定期 (DIN 1988规定为一年一次) 检查安全装置的功能。		排水口		
			Raindrain 中心淋浴盆		
			调节水 / 关闭水流		

 **安装 基础套件 参见第页 42**

 **安装 加工件 参见第页 47**



Указания по технике безопасности

- Во время монтажа следует надеть перчатки во избежание прищемления и порезов.
Изделие разрешается использовать только в гигиенических целях: для принятия ванны и личной гигиены.
Дети, а также взрослые с физическими, умственными и/или сенсорными недостатками должны пользоваться изделием только под присмотром.
Не допускайте попадания струи воды из разбрызгивателя на чувствительные части тела (например, на глаза).
донного клапа. Перед установкой смесителя необходимо регулировочными кранами выровнять давление холодной и горячей воды при помощи вентилей регулирующих подачу воды в квартиру.

Электроподключение

- Электрическое подключение разрешается выполнять только специалисту-электрику!
Питание 100-240V/N/PE/50-60Гц (длина: 0,3 м) установить предварительно.
Требуется организовать защиту с помощью устройства защитного отключения (выключателя дифференциального тока) с уставкой дифференциального тока ≤ 30 мА.
Изделие нужно подключить к выровнителю потенциалов (РА) 4 мм², предусмотренному заказчиком.

Электромонтер

- Установочные и проверочные работы проводятся специалистами-электриками, имеющими допуск к работе, с соблюдением VDE 0100, часть 701, IEC 60364-6, IEC 60364-7-701 и EN 60335-2-105.
Провод для подключения к сети нужно вставить в розетку с двойной изоляцией.

Указания по монтажу

- Перед монтажом следует проверить изделие на предмет повреждений при

перевозке. После монтажа претензии о возмещении ущерба за повреждения при перевозке или повреждения поверхностей не принимаются.

- Трубы и арматура должны быть установлены, промыты и проверены в соответствии с действующими нормами.
Необходимо соблюдать требования по монтажу, действующие в соответствующих странах.
Во время монтажа изделия квалифицированным персоналом поверхность крепления должна быть ровной по всей области крепления (не допускайте выступающих стыков или перекоса облицовочной плитки); для монтажа изделия следует использовать подходящую стену достаточной прочности.
При сверлении обратить внимание на проложенные трубы или электрический кабель!
Слив должен иметь достаточную производительность.
Источник разбрызгивания должен подсоединяться только после запорного клапана или санитарной арматуры.

Технические данные

Table with technical specifications: Рабочее давление в смесителе: не более 1 МПа; Рекомендуемое рабочее давление: 0,3 - 0,5 МПа; Температура горячей воды: не более 60°C; Рекомендуемая темп. гор. воды: 42°C; Предохранительный фиксатор: 40°C; Предупреждение. Превышение этой температуры может привести к ожогам!; Термическая дезинфекция: не более 70°C / 4 мин; Номинальное напряжение: 100-240V AC 50-60Hz; Светильники 4 x LED: 18 W; Яркость лампочки не регулируется; Тип защиты: IPX5.

Описание символов

Grid of symbols and their descriptions: Не применяйте силикон, содержащий уксусную кислоту; Размеры (см. стр. 32); варианты установки (см. стр. 34); Эксплуатация (см. стр. 31); Комплект (см. стр. 31); Гарнитурный Замена источника света (см. стр. 52); Очистка (см. стр. 50) и прилагаемая брошюра; Электромонтер; Техническое обслуживание (см. стр. 53); Прокладка отвода должна осуществляться без нагрузки!; Подключение воды DN20; Теплая вода; Холодная вода; Скрытый вентиль; Четырехходовой переключатель Quattro; Трехходовой запорный и переключающий вентиль Trio Universal; Термостат HighFlow; Слив должен иметь производительность более 50 л/мин.; Слив; Raindrain; Середина душевой ванны; откройте воду / Закройте воду; Полая трубка для электропроводки; Осторожно! Горячая поверхность!; Носите защитные перчатки; Носите средства защиты глаз; Губка из натурального волокна; Удалитель накипи (на основе лимонной кислоты); Избегайте контакта с глазами и кожей. При попадании продукта в глаза, тщательно промойте их водой.; Ток вкл. / выкл.; Знак технического контроля (см. стр. 54).

Монтаж Основной комплект см. стр. 42

Монтаж Наружная часть см. стр. 47





### Biztonsági utasítások

- ⚠ A szerelésnél a zúzódások és vágási sérülések elkerülése érdekében kesztyűt kell viselni.
- ⚠ A terméket csak fürdéshez, mosakodáshoz, és egészségügyi tisztálkodáshoz szabad használni.
- ⚠ Gyermekek, valamint testileg, szellemileg fogyatékos és / vagy érzékelésben korlátozott személyek nem használhatják felügyelet nélkül a terméket. Alkohol és kábítószer befolyása alatt álló személyek nem használhatják a terméket.
- ⚠ Kerülni kell a zuhanyugár érintkezését érzékeny testrészekkel (pl. szemek). Be kell tartani a megfelelő távolságot a zuhanyfej és a test között.
- ⚠ A hidegvíz- és a melegvíz-csatlakozások közötti nagy nyomáskülönbséget k kell egyenlíteni!

### ⚡ Elektromos csatlakozás

- ⚠ Az elektromos hálózathoz való csatlakoztatást csak szakember végezheti el!
- ⚠ A feszültségellátást 100-240V/N/PE/50-60Hz (hosszúság: 0,3 m) előre létre kell hozni.
- ⚠ A biztosítást egy hibaáram-mentesítő (RCD/ FI) útján, egy 30 mA-nál kisebb hálózati váltóáram segítségével kell megvalósítani.
- ⚠ A terméket egy az építkezésen meglévő potenciálkiegyenlítéshez (PA) 4 mm<sup>2</sup> kell csatlakoztatni.

### ⚡ Elektromos szakember

- ⚠ Az installációs és ellenőrző munkákat jóváhagyott elektromos szakembernek kell elvégezni, a VDE 0100 701, IEC 60364-6 része és az IEC 60364-7-701, valamint az EN 60335-2-105 figyelembevételével.
- ⚠ A hálózati csatlakozóvezetékét duplán szigetelve kell   csatlakozódobozba bevezetni.

### Szerelési utasítások





























- A szerelés előtt ellenőrizni kell, hogy a terméknek nincs-e szállítási sérülése. Beépítés után a szállítási- vagy felületi sérüléseket nem ismerik el.
- A vezetékeket és a csaptelepet az érvényes szabványoknak megfelelően kell felszerelni, öblíteni és ellenőrizni
- Az egyes országokban érvényes installációs irányelveket be kell tartani.

- A termék képzett szakember általi felszerelése esetén ügyelni kell arra, hogy a rögzítési felület teljesen sima legyen (ne legyen kiálló fuga vagy csempé), a fal szerkezete a termék felszerelésére alkalmas legyen, és ne legyen gyenge pontja.
- Fúrás esetén ügyelni kell az áram- és vízvezetésekre!
- A kifolyási teljesítményt megfelelően kell dimenzionálni.
- A zuhanyt csak zárószelep vagy szaniter csaptelep után szabad bekötni.

### Műszaki adatok

Üzemi nyomás a csaptelep előtt:	max. 1 MPa
Ajánlott üzemi nyomás:	0,3 - 0,5 MPa
(1 MPa = 10 bar = 147 PSI)	
Forróvíz hőmérséklet:	max. 60 °C
Forróvíz javasolt hőmérséklete:	42 °C
Biztonsági zár:	40 °C
<b>Figyelmeztetés: Ezen hőmérséklet túllépése égési sérüléshez vezet-het!</b>	
Termikus fertőtlenítés:	max. 70 °C / 4 perc
Névleges feszültség	100-240V AC 50-60Hz
Névleges felvétel	18 W
Lámpák 4 x LED:	12V DC SELV 4 W
A lámpa nem halványítható.	
Védelmi osztály	II
Védettség	IPX5

### Szimbólumok leírása

	Ne használjon ecetsavtartalmú szilikont!		Vízcsatlakozás DN20		Bergmannscső a hálózati kapcsolódáshoz
	<b>Méretet</b> (lásd a oldalon 32)		Melegvíz		Vigyázat! Forró felületek!
	<b>Szerelési példák</b> (lásd a oldalon 34)		Vízcsatlakozás DN20		Viseljen védkesztyűt
	<b>Használat</b> (lásd a oldalon 31)		Hidegvíz		Viseljen szemvédőt
	<b>Tartozékok</b> (lásd a oldalon 31)		Falsík alatti szelep		<b>Természetes szivacs</b>
	<b>Szervíz Világítótest cseréje</b> (lásd a oldalon 52)		Quattro négy-utas átalakító		<b>Vízköoldó</b> (citromsav alapú)
	<b>Tisztítás</b> (lásd a oldalon 50) és mellékelt brossúrával		Trio univerzális záró- és váltószelep		Kerülje a szemmel és bőrrel való érintkezést. Ha a termék a szembe jut, akkor bő vízzel mossa ki.
	<b>Elektromos szakember</b>		HighFlow Termosztát HighFlow		Áram be / ki
	<b>Karbantartás</b> (lásd a oldalon 53)		A lefolyó teljesítményének 50l/percnél magasabbnak kell lenni		<b>Vizsgajel</b> (lásd a oldalon 54)
	A biztonsági berendezések működését a DIN EN 1717 szerint rendszeresen, a nemzeti vagy helyi előírásoknak megfelelően (DIN 1988 évente egyszer) ellenőrizni kell.		Lefolyó		
			Zuhanytálca közepe		
			Nyissuk meg a vizet. / Zárjuk el a vizet		

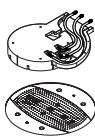

**Szerelés Alapszett lásd a oldalon 42**

**Szerelés A kész szerelvény lásd a oldalon 47**

**Turvallisuusohjeet**

- ⚠ Asennuksessa on käytettävä käsiineitä puristumien ja viiltojen aiheuttamien tapaturmien estämiseksi.
- ⚠ Tuotetta saa käyttää ainoastaan kylpy-, hygieni- ja puhdistustarkoituksiin.
- ⚠ Lapset ja ruumiillisesti, henkisesti ja/tai aistillisesti rajoittuneet aikuiset eivät saa käyttää suihkujärjestelmää ilman valvontaa. Alkoholin tai huumeiden vaikutuksessa olevat henkilöt eivät saa käyttää suihkujärjestelmää.
- ⚠ Suihkuveden kontaktia herkkien ruumiinosien (esim. silmien) kanssa on vältettävä. Suihkun ja vartalon välissä on oltava riittävä väli.
- ⚠ Suuret paine-erot kylmä- ja kuumavesiliitäntöjen välillä on tasattava.

**⚡ Sähköliitäntä**

- ⚠ Sähköliitännän saa tehdä vain sähköalan ammattilainen!
- ⚠ Esiasenna jännitteensyöttö 100-240V/N/PE/50-60Hz (pituus: 0,3 m).
- ⚠ Varmistus on tehtävä vikavirtasuojalaitetta (RCD/FI), jonka vikavirta-asetus on  $\leq$  30 mA, käyttäen.
- ⚠ Tuote pitää liittää rakennuksessa olevaan potentiaalitasaukseen (PA) 4 mm<sup>2</sup>.

**⚡ Sähköasentaja**

- ⚠ Hyväksytyt sähköammattilaisen on suoritettava sähköasennus- ja tarkastustyöt VDE 0100 osa 701, IEC 60364-6 ja IEC 60364-7-701 sekä EN 60335-2-105 mukaisesti.
- ⚠ Sen verkkoliitäntäjohdon, johon liitäntärasia liitetään, tulee olla kaksoiseristetty.

**Asennusohjeet**

- Ennen asennusta on tarkastettava tuotteen mahdolliset kuljetusvahingot. Asennuksen jälkeen kuljetus- ja pintavaurioita ei hyväksytä.
- Putket ja hana on asennettava, huuhdeltava ja tarkastettava voimassa olevien standardien mukaisesti.
- Jokaisessa maassa on noudatettava siellä päteviä asennusohjeita.
- Pätevän ammattihenkilöstön asentaessa tuotetta on otettava huomioon, että kiinnityspinnan on oltava koko kiinnitysalueelta tasainen (ei korkeita saumoja tai laattojen yhtymäkohtia), seinän rakenne soveltuu tuotteen asennukseen eikä siinä ole heikkoja kohtia.

- Varo porattaessa sähkö- ja vesijohtoja!
- Poisvirtausteho on mitoitettava riittävän suureksi.
- Suihkun saa liittää vain sulkuventtiiliin tai saniteettiarmatuuriin.

**Tekniset tiedot**

Käyttöpainne ennen kalustetta:	maks. 1 MPa
Suosittelut käyttöpainne:	0,3 - 0,5 MPa
(1 MPa = 10 bar = 147 PSI)	
Kuuman veden lämpötila:	maks. 60°C
Kuuman veden suosituslämpötila:	42°C
Turvaestin:	40°C
<b>Varoitus: Tämän lämpötilan ylittäminen voi aiheuttaa palovammoja!</b>	
Lämpödesinfektio:	maks. 70°C / 4 min
Nimellijännite	100-240V AC 50-60Hz
Nimellisottoteho	18 W
Valaisimet 4 x LED:	12V DC SELV 4 W
Valaisin ei ole himmennettävissä.	
Suojausluokka	II
Suojausluokka	IPX5

**Merkin kuvaus**

	Älä käytä etikkahappopitoista silikonia!		Vesiliitäntä DN20		Tyhjä putki virran syöttöä varten
	<b>Mitat</b> (katso sivu 32)		Lämmin vesi		Varoitus kuumasta pinnasta!
	<b>Asennusesimerkkejä</b> (katso sivu 34)		Vesiliitäntä DN20		Käytä suojakäsineitä
	<b>Käyttö</b> (katso sivu 31)		Kylmä vesi		Käytä silmäsuojuksia
	<b>Varaosat</b> (katso sivu 31)		Upotettava venttiili		<b>Luonnonsieni</b>
	<b>Service Valonlähteen vaihto</b> (katso sivu 52)		4-tiesäätöventtiili		<b>Kalkinpoistaja</b> (sitruunahappopohjainen)
	<b>Puhdistus</b> (katso sivu 50) ja oheinen esite		Trio -sulku- ja säätöventtiili		Vältä silmä- ja ihokosketusta. Jos tuotetta pääsee silmiin, huuhtelee silmät perusteellisesti vedellä.
	<b>Sähköasentaja</b>		High Flow		Sähkö päällä / pois päältä
	<b>Huolto</b> (katso sivu 53)		Termostaatti HighFlow		<b>Koestusmerkki</b> (katso sivu 54)
	Turvallisuuden toiminta on tarkastettava DIN EN 1717:n mukaisesti säännöllisin väliajoin kansallisten ja paikallisten määräysten mukaisesti (DIN 1988: kerran vuodessa).		Poisvirtaustehon on oltava enemmän kuin 50l/min.		
			Veden poisvirtaus		
			Raindrain X		
			Suihkualtaan keskusta		
			Avaa vedensyöttö / Sulje vedentulo		

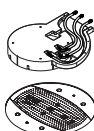
**Asennus Perussarja katso sivu 42****Asennus Valmissarja katso sivu 47**





## Säkerhetsanvisningar

- ⚠ Handskar ska bäras under monteringsarbetet så att man kan undvika kläm- och skärskadorna werden.
- ⚠ Produkten får bara användas till kroppshygien med bad och dusch.
- ⚠ Barn samt vuxna med fysiska, psykiska eller sensoriska funktionshinder får inte använda produkten ensamma. Personer som är påverkade av alkohol- eller droger får inte använda produkten.
- ⚠ Undvik att rikta duschstrålarna mot känsliga kroppsdelar (t. ex. ögonen). Det måste finnas ett tillräckligt stort avstånd mellan duschen och kroppen.
- ⚠ Stora tryckskillnader mellan anslutningarna för varmt och kallt vatten måste utjämnas.

### ⚡ Elektrisk anslutning

- ⚠ Elanslutningen får endast utföras av en elektroinstallatör!
- ⚠ Förinstallera nätspänning 100-240V/N/PE/50-60Hz (längd: 0,3 m).
- ⚠ Säkringen måste ske via en felströms-skyddsanordning (RCD/ FI) med en differensström på  $\leq 30$  mA.
- ⚠ Produkten ska anslutas till en på plats befintlig potentialutjämning (PA) 4 mm<sup>2</sup>.

### ⚡ Elinstallatör

- ⚠ Installations- och kontrollarbeten ska utföras av behörig elektroinstallatör, enligt VDE 0100 del 701, IEC 60364-6 o. IEC 60364-7-701 samt EN 60335-2-105.
- ⚠ Nätkabeln ska införas dubbelt isolerad  i koppling dosan.

## Monteringsanvisningar































- Det måste undersökas om produkten har transportskador innan den monteras. Efter monteringen accepteras inga transport- eller ytskiktsskador.
- Ledningarna och blandaren måste monteras, spolats igenom och kontrolleras enligt de gällande normerna.
- De installationsriktlinjer som gäller i länderna ska följas.
- När kvalificerad fackpersonal monterar produkten är det viktigt att fästytan är plan över hela festsättningsområdet (inga fogar som sticker ut eller kakelförskjutning) och att väggstrukturen är lämplig för en montering av produkten och inte har några svaga punkter.

- Tänk på elledningar och vattenrör vid borring!
- Tömningskapaciteten måste vara tillräcklig.
- Duschen får bara anslutas efter en spärrventil eller sanitärblandare.

## Tekniska data

Driftstryck framför blandaren:	max. 1 MPa
Rek. driftstryck:	0,3 - 0,5 MPa
(1 MPa = 10 bar = 147 PSI)	
Varmvattentemperatur:	max. 60 °C
Rek. varmvattentemp.:	42 °C
Säkerhetsspärr:	40 °C
<b>Varning: om angiven temperatur överskrids kan detta leda till förbränningar!</b>	
Termisk desinfektion:	max. 70 °C / 4 min
Nominell spänning	100-240V AC 50-60Hz
Nominell förbrukning	18 W
Lampa 4 x LED:	12V DC SELV 4 W
Lampan kan inte dimmas.	
Skyddsklass	II
Skyddstyp	IPX5

## Symbolförklaring

	Använd inte silikon som innehåller ättiksyra!		Vattenanslutning DN20		Tomledning för stömförsörjning
	<b>Måtten</b> (se sidan 32)		Varmvatten		Varning för het yta!
	<b>Monteringsexempel</b> (se sidan 34)		Vattenanslutning DN20		Bär skyddshandskar
	<b>Hantering</b> (se sidan 31)		Kallvatten		Bär ögonskydd
	<b>Reservdelar</b> (se sidan 31)		Invändig ventil		<b>Natursvamp</b>
	<b>Service Byta glödlampa</b> (se sidan 52)		Quattro Fyrvägsomkastare		<b>Avkalkningsmedel</b> (citronsyra-bas)
	<b>Rengöring</b> (se sidan 50) och medföljande broschyr		Trio Universell avstängningsventil och omkastare		Undvik ögon- och hudkontakt. Skulle produkten hamna i ögonen så spola ur dem grundligt med vatten.
	<b>Elinstallatör</b>		Trio HighFlow		Ström på / av
	<b>Skötsel</b> (se sidan 53)		Termostat HighFlow		<b>Testsigill</b> (se sidan 54)
	Enligt DIN EN 1717 måste säkerhetsanordningarnas funktion kontrolleras regelbundet och i överensstämmelse med nationella eller regionala bestämmelser (DIN 1988 en gång per år).		Avloppet måste klara mer än 50 l/min.		
			Avlopp		
			Miiten av duschkaret		
			Slå på vatten / Stäng av vattnet		

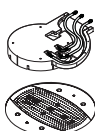

**Montering Grundset se sidan 42**

**Montering Färdigset se sidan 47**

**Saugumo technikos nurodymai**

- ⚠️ Apsaugai nuo užspaudimo ir įsipjovimo montavimo metu mūvėkite pirštines.
- ⚠️ Gaminys turi būti naudojamas tik maudymuisi, kūno higienai ir švarai palaikyti.
- ⚠️ Gaminį draudžiama naudoti vaikams, taip pat suaugusiems su fizine, dvasine negale ir (arba) sensorikos sutrikimais. Gaminį taip pat draudžiama naudoti asmenims, apsvaigusiems nuo alkoholio arba narkotikų.
- ⚠️ Būtina vengti dušo vandens srovės kontakto su jautriomis kūno vietomis (pvz., akimis). Todėl būtina laikytis tinkamu atstumu nuo dušo.
- ⚠️ Turi būti išlyginti šalto ir karšto slėgio nelygumai.

**⚡ Elektros prijungimas**

- ⚠️ Elektrą prijungti turi elektrikas!
- ⚠️ Iš anksto parenkite maitinimo šaltinį 100-240 V / N / PE / 50-60 Hz (0,3 m ilgio).
- ⚠️ Apsauginis įrenginys (RCD / FI) apsaugo nuo nebalanso srovės, kai srovių skirtumas  $\leq 30$  mA .
- ⚠️ Gaminį reikia prijungti prie montavimo vietoje esančio potencialų išlyginimo įtaiso (PA) 4 mm<sup>2</sup>.

**⚡ Elektromontuotojas**

- ⚠️ Įrengimo ir tikrinimo darbus gali atlikti tik kvalifikuoti elektrikai pagal VDE 0100 701 d. ir IEC 60364-7-701, IEC 60364-6 bei 60335-2-105 standartų reikalavimus.
- ⚠️ Dvigubai izoliuotą prijungimo prie tinklo laidą  į eskite į jungiamąjį lizdą.

**Montavimo instrukcija**

- Prieš montuojant būtina patikrinti, ar gaminys nebuvo pažeistas transportavimo metu. Sumontavus pretenzijos dėl transportavimo ir paviršiaus pažeidimų nepriimamos.
- Vamzdžiai ir sujungimai turi būti montuojami, plaunami ir tikrinami pagal galiojančias normas.
- Laikykites atitinkamoje šalyje galiojančių direktyvų dėl įrengimo.
- Atlikdami montavimo darbus, kvalifikuoti darbuotojai turi atkreipti dėmesį, kad pritvirtinimo plokštuma būtų lygi (be išsikišusių siūlių ar perkreiptų plytelių), sienų konstrukcija tiktų gaminiiui montuoti ir neturėtų jokių trūkumų.

- Gręžiant atkreipkite dėmesį į esamas elektros ir vandens linijas
- Vandens nubėgimas privalo būti pakankamas.
- Dušo galvą galima prijungti tik už uždarymo vožtuvo arba sanitarinio maišytuvo.

**Techniniai duomenys**

Darbinis slėgis prieš maišytuvą:	ne daugiau kaip 1 MPa
Rekomenduojamas slėgis:	0,3 - 0,5 MPa
(1 MPa = 10 barų = 147 PSI)	
Karšto vandens temperatūra:	ne daugiau kaip 60°C
Rekomenduojama karšto vandens temperatūra:	42°C
Apsauginė blokuotė:	40°C
<b>Įspėjimas: dėl padidėjusios temperatūros kyla nudegimų grėsmė!</b>	
Terminis dezinfekavimas:	ne daugiau kaip 70°C / 4 min
Nominali įtampa	100-240V AC 50-60Hz
Nominalioji imamoji galia	18 W
Šviestuvai 4 x LED:	12V DC SELV 4 W
Žibinto šviesos ryškumas nereguliuojamas.	
Apsaugos klasė	II
Apsaugos tipas	IPX5

**Simbolio aprašymas**

 Nenaudokite silikono, kurio sudėtyje yra acto rūgšties!

 **Išmatavimai** (žr. psl. 32)

 **Montavimo pavyzdžiai** (žr. psl. 34)

 **Eksploatacija** (žr. psl. 31)

 **Atsarginės dalys** (žr. psl. 31)

 **Priežiūros šviesos šaltinio pakeitimas** (žr. psl. 52)

 **Valymas** (žr. psl. 50) ir pridama brošiūra

 **Elektromontuotojas**

 **Techninis aptarnavimas** (žr. psl. 53)

Pagal DIN EN 1717 ir nacionalines arba regionines direktyvas reikia reguliariai tikrinti saugos įrangos veikimą (pagal DIN 1988 - kartą per metus).

 Vandens prijungimas DN20

 Šiltas vanduo

 Vandens prijungimas DN20

 Šaltas vanduo

 Potinkinis uždarymo vožtuvas

 „Quattro“ 4-krypčių perjungimas

 Užvarinis ir perjungimo vožtuvas „Trio Universal“

 „Trio HighFlow“

 Termostatas HighFlow

 Nutekėjimo našumas turi būti ne mažesnis 50 l/min

 Nutekėjimas

 Raindrain Dušo padėklo centras

 Įjunkite vandens tiekimą / Išjungti vandens tiekimą

 Tuščiaaviduris vamzdelis elektros aprūpinimui

 Karštas paviršius!

 Mūvėkite apsaugines pirštines

 Dėvėkite akių apsaugines priemones

 **Natūrali kempinė**

 **Nukalkintojas** (citrinos rūgšties pagrindu)

Venkite, kad produkto nepatektų į akis ir ant odos. Patekus į akis, jas kruopščiai nuplaukite vandeniu.

 Srovė įj./ išj.

 **Bandymo pažyma** (žr. psl. 54)

**Montavimas Pagrindinis komplektas žr. psl. 42****Montavimas Virštinkinė žr. psl. 47**



## Sigurnosne upute

- ⚠ Prilikom montaže se radi sprječavanja prignječenja i posjekotina moraju nositi rukavice.
- ⚠ Proizvod se smije primjenjivati samo za kupanje, tuširanje i osobnu higijenu.
- ⚠ Djeca, kao i tjelesno, mentalno i/ili senzorno hendikepirane odrasle osobe ne smiju se koristiti proizvodom bez nadzora. Osobe koje su pod utjecajem alkohola ili droga ne smiju se koristiti proizvodom.
- ⚠ Mora se izbjegavati kontakt mlaza iz tuša s osjetljivim dijelovima tijela (npr. očima). Tijelo korisnika mora biti dovoljno udaljeno od tuša.
- ⚠ Velika razlika u pritisku između vruće i hladne vode mora biti izbalansirana.

### Električni priključak

- ⚠ Električnu smije priključiti samo ovlašteni električar!
- ⚠ Prethodno priključite naponsko napajanje 100-240V/N/PE/50-60Hz (duljina: 0,3 m).
- ⚠ Vod se mora osigurati nadstrujnom zaštitnom sklopkom (RCD/FI) s nazivnom diferencijalnom strujom  $\leq 30$  mA.
- ⚠ Proizvod se mora priključiti na postojeće izjednačenje potencijala (PA) 4 mm<sup>2</sup>.

### elektroinstalater

- ⚠ Električne instalacijske i ispitne radove smiju obavljati samo certificirani električari uz uvažavanje odredaba VDE 0100 dio 701, IEC 60364-6 i IEC 60364-7-701 te EN 60335-2-105.
- ⚠ Strujni priključni kabel mora se dvostruko izoliran  uvesti u priključnicu.

## Upute za montažu































- Prije montaže mora se provjeriti je li proizvod oštećen prilikom transporta. Nakon ugradnje se ne priznaju nikakve reklamacije koje se odnose na površinska i transportna oštećenja.
- Cijevi i armatura moraju biti postavljeni, isprani i testirani prema važećim normama.
- Obvezno se moraju uvažiti propisi o instalacijama koji vrijede u dotičnoj zemlji.
- Kada proizvod montira kvalificirano stručno osoblje treba paziti da čitava površina na koju se učvršćuje bude ravna (bez istaknutih fuga ili krivljenja pločica), da je zidna konstrukcija primjerena montaži proizvoda te da nema slabih mjesta.

- Prilikom bušenja treba paziti na strujne vodove i vodovodne cijevi!
- Potreban je optimalan protok vode
- Tuš se smije priključivati samo iza zapornog ventila ili iza sanitarne armature.

## Tehnički podatci

Radni tlak ispred armature:	tlak 1 MPa
Preporučeni tlak:	0,3 - 0,5 MPa
(1 MPa = 10 bar = 147 PSI)	
Temperatura vruće vode:	tlak 60°C
Preporučena temperatura vruće vode:	42°C
Sigurnosni zapor:	40°C
<b>Upozorenje: Prekoračenje ove temperature može izazvati opekline!</b>	
Termička dezinfekcija:	tlak 70°C / 4 min
Nazivni napon	100-240V AC 50-60Hz
Nazivna potrošnja	18 W
Svjetiljke 4 x LED:	12V DC SELV 4 W
Svjetiljka se ne može prigušiti.	
Stupanj zaštite	II
Stupanj zaštite	IPX5

## Opis simbola

	Nemojte koristiti silikon koji sadrži octenu kiselinu!		priključak na dovod vode DN20		šuplja cijev za električno napajanje
	<b>Mjere</b> (pogledaj stranicu 32)		Topla voda		Upozorenje na opasnost od vrela površine!
	<b>Primjeri instalacija</b> (pogledaj stranicu 34)		priključak na dovod vode DN20		Nosite zaštitne rukavice
	<b>Upotreba</b> (pogledaj stranicu 31)		Hladna voda		Nosite zaštitne naočale
	<b>Rezervni dijelovi</b> (pogledaj stranicu 31)		Podžbukni ventil		<b>prirodna spužva</b>
	<b>Servisna Zamjena rasvjetnih tijela</b> (pogledaj stranicu 52)		Quattro četverostruki preusmjernivač		<b>Sredstvo za uklanjanje kamenca</b> (na bazi limunske kiseline)
	<b>Čišćenje</b> (pogledaj stranicu 50) i priložena brošura		Trio Universal ventil za zatvaranje i ventil selektora		Izbjegavajte kontakt s očima i kožom. U slučaju kontakta s očima, temeljito isperite s dosta vode.
	<b>elektroinstalater</b>		Trio HighFlow		
	<b>Održavanje</b> (pogledaj stranicu 53)		Termostat HighFlow		
	Ispravno funkcioniranje sigurnosnih elemenata se mora redovito provjeravati prema standardu DIN EN 1717 i sukladno važećim nacionalnim ili regionalnim propisima (DIN 1988 jednom godišnje).		Protok vode mora biti veći od 50 l/min.		Struja uklj. / isklj.
			Odvod		<b>Oznaka testiranja</b> (pogledaj stranicu 54)
			Sredina tuš-kada		
			Otvorite dotok vode / Zatvorite vodu		



**Sastavljanje osnovna garnitura pogledaj stranicu 42**



**Sastavljanje Završni set pogledaj stranicu 47**



## Güvenlik uyarıları

- ⚠ Montaj esnasında ezilme ve kesilme gibi yaralanmaları önlemek için eldiven kullanılmalıdır.
- ⚠ Ürün yalnızca banyo, hijyen ve beden temizliği amaçları doğrultusunda kullanılabilir.
- ⚠ Bedensel, ruhsal ve/veya sensörük engelli çocuk ve yetişkinler gözetimsiz olarak duş sistemini kullanmamalıdır. Alkol veya uyuşturucu etkisinde olanlar duş sistemini kullanmamalıdır.
- ⚠ Püskürtme başlıklarının hassas organlara teması (örn. gözler) önlenmelidir. Püskürtücü ile beden arasında yeterli mesafe bırakılmalıdır.
- ⚠ Sıcak ve soğuk su bağlantıları arasında büyük basınç farklılıkları varsa, bu basınç farklılıklarının dengelenmesi gerekir.

## ⚡ Elektrik bağlantısı

- ⚠ Elektrik bağlantısı sadece bir elektrik teknisyeni tarafından yapılmalıdır!
- ⚠ Gerilim beslemesini 100-240V/N/PE/50-60Hz (uzunluk: 0,3 m) önceden kurun.
- ⚠ Emniyete alma,  $\leq 30$  mA ölçüm farkı akımı olan bir hatalı akım koruma tertibatı (RCD/FI) üzerinden gerçekleştirilmelidir.
- ⚠ Ürün, yapı tarafı mevcut bir potansiyel dengelemesine (PA) 4 mm<sup>2</sup> bağlanmalıdır.

## ⚡ Elektronik montajcısı

- ⚠ Kurulum ve kontrol çalışmaları, VDE 0100 Bölüm 701, IEC 60364-6 ve IEC 60364-7-701'i ve EN 60335-2-105'i dikkate almak suretiyle, elektronik konusunda uzman yetkili bir kişi tarafından gerçekleştirilmelidir.
- ⚠ Şebeke bağlantı hattı çift izole  biçiminde bağlantı utusuna yerleştirilmelidir.

## Montaj açıklamaları

































- Montaj işleminden önce ürün nakliye hasarları yönünden kontrol edilmelidir. Montaj işleminden sonra nakliye veya yüzey hasarları için sorumluluk üstlenilmemektedir.
- Boruların ve armatürün montajı, yıkanması ve kontrolü geçerli normlara göre yapılmalıdır.
- Ülkelerde geçerli kurulum yönetmeliklerine riayet edilmelidir.

- Ürünün yetkili uzman personel tarafından montajı yapılırken, sabitleme yüzeyinin sabitleme planının tüm alanında bulunduğu (derz veya fayans kayması olmamalıdır), duvar yapısının ürünün montajı için uygun olduğuna ve zayıf noktaları bulunmadığına dikkat edilmelidir.
- Delik açarken elektrik ve su hatlarına dikkat!
- Çıkış kapasitesi yeterli miktarda boyutlandırılmış olmalıdır.
- Su püskürtücü yalnızca sıhhi armatür veya kapatma vanasından sonra bağlanabilir.

## Teknik bilgiler

Bataryadan önceki işletme basıncı	azami 1 MPa
Tavsiye edilen işletme basıncı:	0,3 - 0,5 MPa
(1 MPa = 10 bar = 147 PSI)	
Sıcak su sıcaklığı:	azami 60 °C
Tavsiye edilen su ısısı:	42 °C
Güvenlik blokajı:	40 °C
<b>Uyarı: Bu sıcaklığın aşılması, yanmalara neden olabilir!</b>	
Termik dezenfeksiyon:	azami 70 °C / 4 dak
Nominal gerilim	100-240V AC 50-60Hz
Nominal giriş	18 W
Lambalar 4 x LED:	12V DC SELV 4 W
Aydınlatma maddesi kısılamaz.	
Koruma sınıfı	II
Koruma türü	IPX5

## Simge açıklaması

	Asetik asit içeren silikon kullanmayın!		Su bağlantısı DN20		Akım beslemesi için boş boru
	<b>Ölçüleri</b> (bakınız sayfa 32)		Sıcak su		Sıcak yüzeye karşı uyarı!
	<b>Montaj Örneği</b> (bakınız sayfa 34)		Su bağlantısı DN20		Koruyucu eldiven kullanın
	<b>Kullanımı</b> (bakınız sayfa 31)		Soğuk su		Göz koruyucu kullanın
	<b>Yedek Parçalar</b> (bakınız sayfa 31)		Sıva altı valfi		<b>Doğal Sünger</b>
	<b>Servis Ampul değiştirme</b> (bakınız sayfa 52)		Quattro dört yöllü değiştirme		<b>Kireç sökücü</b> (Limon asidi temeli)
	<b>Temizleme</b> (bakınız sayfa 50) ve birlikte verilen broşür		Trio ünlversal kapatma ve değiştirme valfi		Gözlere ve cilde temasından kaçının. Eğer ürün gözlere bulaşırsa, gözlerinizi su ile iyice yıkayın.
	<b>Elektronik montajcısı</b>		Trio High Flow		
	<b>Bakım</b> (bakınız sayfa 53)		Termostat HighFlow		
	Emniyet tertibatları DIN EN 1717 uyarınca düzenli olarak ulusal veya bölgesel yönetmeliklere göre (DIN 1988 uyarınca yılda bir kez), işlev yönünden kontrol edilmelidir.		Akış kapasitesi 50 l/dak üzerinde olmalıdır.		
			Akış		Akım açık / kapalı
			Raindrain		<b>Kontrol işareti</b> (bakınız sayfa 54)
			X		
			Duş küvetinin ortası		
			Suyu açın / Suyu kesin		



**Montaj Ana set bakınız sayfa 42**



**Montaj Dışı set bakınız sayfa 47**



## Instrucțiuni de siguranță

- ⚠ La montare utilizați mănuși pentru evitarea contuziunilor și tăierii mâinilor.
- ⚠ Produsul poate fi utilizat doar pentru spălarea, menținerea igienei și curățarea corpului.
- ⚠ Copiii și adulții cu dizabilități corporale, mintale și senzoriale nu pot utiliza sistemul de duș nesupravegheați. De asemenea este interzisă utilizarea sistemului de duș de către persoane, care se află sub influența alcoolului sau a drogurilor.
- ⚠ Evitați contactul jetului de apă cu părțile de corp sensibile (de ex. ochii). Țineți dușul la o distanță corespunzătoare de corp.
- ⚠ Diferențele de presiune mari între alimentarea cu apă rece și apă caldă trebuie echilibrate.

### ⚡ Conexiune electrică

- ⚠ Racordarea la rețeaua electrică poate fi efectuată numai de către un tehnician electronist specializat!
- ⚠ Preinstalați 100-240V/N/PE/50-60Hz (lungime: 0,3 m) cablul de alimentare cu curent.
- ⚠ Instalația trebuie asigurată printr-un dispozitiv de protecție împotriva curentului rezidual (RCD/ FI) pentru curent rezidual măsurat de  $\leq 30$  mA.
- ⚠ Produsul trebuie conectat la un egalizator de potențial la fața locului (PA) 4 mm<sup>2</sup>.

### ⚡ Electrician

- ⚠ Lucrările de instalare și de verificare trebuie efectuate de către electricieni specializați, ținând cont de VDE 0100 Partea 701, IEC 60364-6 și IEC 60364-7-701, cât și EN 60335-2-105.
- ⚠ Cablul de alimentare de la rețea trebuie introdus dublu izolat  în cutia de conexiuni.

## Instrucțiuni de montare

- Înainte de instalare verificați, dacă produsul prezintă deteriorări de transport. După instalare garanția nu acoperă deteriorările de transport și cele de suprafață.
- Conductele și bateriile trebuie montate, spălate și verificate conform normelor în vigoare.

- Respectați reglementările referitoare la instalare valabile în țara respectivă.
- La montarea produsului de către un personal calificat se va avea grijă ca suprafața de fixare să fie plană pe toată aria de fixare (fără proeminențe ale rosturilor sau îmbinări între plăcile de faianță) și ca structura peretelui să fie corespunzătoare pentru fixarea produsului, să nu prezinte locuri cu rezistență redusă.
- La efectuarea lucrărilor de găurire fiți atenți la conductele de apă și cablurile electrice!
- Debitul de golire trebuie să fie suficient de mare.
- Dușul poate fi instalat doar după un ventil de închidere sau o armătură sanitară.

## Date tehnice

Presiune de funcționare înainte de baterie:	max. 1 MPa
Presiune de funcționare recomandată:	0,3 - 0,5 MPa
(1 MPa = 10 bar = 147 PSI)	
Temperatura apei calde:	max. 60 °C
Temperatura recomandată a apei calde:	42 °C
Blocaj de siguranță:	40 °C
<b>Atenție: depășirea acestei temperaturi poate cauza arsuri!</b>	
Dezinfecție termică:	max. 70 °C / 4 min
Tensiune nominală	100-240V AC 50-60Hz
Putere nominală	18 W
Lămpi 4 x LED:	12V DC SELV 4 W
Intensitatea luminii nu este reglabilă.	
Clasă de protecție	II
Clasă de protecție	IPX5

## Descrierea simbolurilor

	Nu utilizați silicon cu conținut de acid acetic!		Racord de apă DN20		Tub pentru conductele de alimentare electrică
	<b>Dimensiuni</b> (vezi pag. 32)		Apă caldă		Atenție la suprafața fierbinte!
	<b>Exemple de montare</b> (vezi pag. 34)		Racord de apă DN20		Purtați mănuși de protecție
	<b>Utilizare</b> (vezi pag. 31)		Apă rece		Purtați ochelari de protecție
	<b>Piese de schimb</b> (vezi pag. 31)		Ventil montat sub tencuială		<b>Burete natural</b>
	<b>service Înlocuirea luminii</b> (vezi pag. 52)		Quattro valvă de inversare cu patru căi		<b>Soluție de decalcifiere</b> (bază de acid citric)
	<b>Curățare</b> (vezi pag. 50) și broșura alăturată		Trio valvă de închidere și de inversare universală		Evitați contactul cu ochii și cu pielea. În cazul în care produsul ajunge în contact cu ochii, clătiți bine cu apă.
	<b>Electrician</b>		Termostat HighFlow		Curent pornit / oprit
	<b>Întreținere</b> (vezi pag. 53)		Capacitatea de evacuare trebuie să fie mai mare de 50 l/min.		<b>Certificat de testare</b> (vezi pag. 54)
	Dispozitivele de siguranță trebuie verificate regulat conform DIN EN 1717 și în conformitate cu reglementările naționale și regionale (o dată pe an conform DIN 1988).		Deversor		
			În mijlocul căzii de duș		
			Se introduce apa / Opriți alimentarea cu apă		



**Montare Set de bază vezi pag. 42**



**Montare Set complet vezi pag. 47**



## Υποδειξεις ασφαλείας

- ⚠ Για να αποφύγετε τραυματισμούς κατά τη συναρμολόγηση πρέπει να φοράτε γάντια.
- ⚠ Το προϊόν επιτρέπεται να χρησιμοποιείται μόνο σαν μέσο λουτρού, υγιεινής και καθαρισμού του σώματος.
- ⚠ Παιδιά ή ενήλικες με μειωμένες σωματικές, διανοητικές και/ή αισθητήριες ανεπάρκειες δεν επιτρέπεται να χρησιμοποιούν το προϊόν χωρίς επιτήρηση. Άτομα υπό την επήρεια οινοπνεύματος ή ναρκωτικών δεν επιτρέπεται να χρησιμοποιούν σε καμία περίπτωση το προϊόν.
- ⚠ Η επαφή δέσμης νερού του ντους με ευαίσθητες περιοχές του σώματος (π.χ. μάτια) πρέπει να αποφεύγεται. Διατηρείτε επαρκή απόσταση ανάμεσα στο ντους και το σώμα.
- ⚠ Οι διαφορές της πίεσης μεταξύ της σύνδεσης κρύου και ζεστού νερού θα πρέπει να αντισταθμίζονται.

## Ηλεκτρική παροχή

- ⚠ Η ηλεκτρική εγκατάσταση επιτρέπεται να πραγματοποιηθεί μόνο από εξειδικευμένο ηλεκτρολόγο!
- ⚠ Παροχή ρεύματος 100-240V/N/PE/50-60Hz (Μήκος: 0,3 μέτρα) προεγκατάσταση.
- ⚠ Η ασφάλιση θα πρέπει να πραγματοποιείται μέσω διάταξης προστασίας ρεύματος διαρροής (RCD/ FI) με παραμένον ρεύμα  $\leq 30$  mA.
- ⚠ Το προϊόν πρέπει να συνδεθεί με μία ισοδυναμική σύνδεση (PA) 4 mm<sup>2</sup> που έχει προεγκατασταθεί από τον πελάτη.

## Ηλεκτρολόγος εγκατάστασης

- ⚠ Οι εργασίες εγκατάστασης και ελέγχου πρέπει να διενεργούνται από έναν εγκεκριμένο ειδικό ηλεκτρολόγο, λαμβάνοντας υπόψη τις οδηγίες VDE 0100 Μέρος 701, IEC 60364-6 και IEC 60364-7-701 καθώς και το EN 60335-2-105.
- ⚠ Το καλώδιο σύνδεσης πρέπει να εισαχθεί με διπλή μόνωση στο κουτί σύνδεσης.

## Οδηγίες συναρμολόγησης

- Πριν τη συναρμολόγηση πρέπει να εξεταστεί το προϊόν για ζημιές μεταφοράς. Μετά την εγκατάσταση δεν αναγνωρίζονται ζημιές από τη μεταφορά ή επιφάνεια-

κές ζημιές.

- Οι σωλήνες και η μπαταρία πρέπει να τοποθετηθούν σύμφωνα με τα ισχύοντα πρότυπα, να τεθούν υπό πίεση και να δοκιμαστούν.
- Θα πρέπει να τηρούνται οι οδηγίες εγκατάστασης που ισχύουν σε κάθε κράτος.
- Κατά τη συναρμολόγηση του προϊόντος από ειδικό προσωπικό θα πρέπει να ελέγχεται με ιδιαίτερη προσοχή η επιφάνεια στερέωσης, αν είναι επίπεδη σε όλη της την επιφάνεια (δεν πρέπει να εξέχουν αρμοί ή πλακάκια), αν η υποδομή του τοίχου είναι κατάλληλη για τη στερέωση του προϊόντος και αν παρουσιάζει ασθενή σημεία.
- Προσοχή όταν τρυπάτε πάνω από σωλήνες ηλεκτρικού ή νερού!
- Η κατανάλωση νερού πρέπει να έχει επαρκείς διαστάσεις.
- Το ντους επιτρέπεται να συνδέεται μόνο αφού προηγηθεί στο κύκλωμα μία βαλβίδα διακοπής ή μπαταρία.

## Τεχνικά Χαρακτηριστικά

Πίεση λειτουργίας προ της βάνας:	έως 1 MPa
Συνιστώμενη λειτουργία πίεσης:	0,3 - 0,5 MPa
(1 MPa = 10 bar = 147 PSI)	
Θερμοκρασία ζεστού νερού:	έως 60 °C
Συνιστώμενη θερμοκρασία ζεστού νερού:	42 °C
Ασφάλεια υπερθέρμανσης νερού	40 °C
<b>Προειδοποίηση: Υπέρβαση αυτής της θερμοκρασίας μπορεί να προκαλέσει εγκαύματα</b>	
Θερμική απολύμανση:	έως 70 °C / 4 min
Ονομαστική τάση	100-240V AC 50-60Hz
Ονομαστική ισχύς	18 W
Φωτιστικά 4 x LED:	12V DC SELV 4 W
Το φωτιστικό δεν διαθέτει ροοστάτη.	
Κατηγορία προστασίας	II
Είδος προστασίας	IPX5

## Περιγραφή συμβόλων

Μην χρησιμοποιείτε σιλικόνη που περιέχει οξικό οξύ!	Παροχή νερού DN20	Κενός σωλήνας για την παροχή ρεύματος
<b>Διαστάσεις</b> (βλ. Σελίδα 32)	Ζεστό νερό	Προειδοποίηση: καυτή επιφάνεια!
<b>Παραδείγματα συναρμολόγησης</b> (βλ. Σελίδα 34)	Παροχή νερού DN20	Φοράτε γάντια προστασίας χεριών
<b>Χειρισμός</b> (βλ. Σελίδα 31)	Κρύο νερό	Φοράτε γυαλιά προστασίας ματιών
<b>Ανταλλακτικά</b> (βλ. Σελίδα 31)	Χωνευτή βαλβίδα	<b>Φυσικός σπόγγος</b>
<b>Οέρβις Αντικατάσταση φωτιστικού</b> (βλ. Σελίδα 52)	Quattro τετράοδης μετατροπής	<b>Αποσκληρυντής νερού</b> (με βάση το κιτρικό οξύ)
<b>Καθαρισμός</b> (βλ. Σελίδα 50) και συνημμένο φυλλάδιο	Trio Universal βαλβίδα κλεισίματος και εκτροπής	Αποφεύγετε την επαφή με τα μάτια και το δέρμα. Σε περίπτωση που έλθει το προϊόν σε επαφή με τα μάτια ξεπλύνετε καλά με νερό.
<b>Ηλεκτρολόγος εγκατάστασης</b>	Trio HighFlow	Ρεύμα on / off
<b>Συντήρηση</b> (βλ. Σελίδα 53)	Η αποχετευτική ικανότητα της βαλβίδας εκροής πρέπει να υπερβαίνει τα 1/min.	<b>Σήμα ελέγχου</b> (βλ. Σελίδα 54)
Οι διατάξεις ασφαλείας πρέπει να ελέγχονται σύμφωνα με το DIN EN 1717 τακτικά σύμφωνα με τις εθνικές ή τοπικές διατάξεις (DIN 1988 μία φορά τον χρόνο) ως προς τη λειτουργία τους.	> 50 l/min	
	Βαλβίδα εκροής	
	Raindrix	
	Μέσον της ντουσιέρας	
	X	
	Ανοίξτε την παροχή του νερού / Κλείστε την παροχή νερού	



**Συναρμολόγηση Βασικό σετ βλ. Σελίδα 42**



**Συναρμολόγηση Σετ μηχανισμού βλ. Σελίδα 47**



## Varnostna opozorila

- ⚠ Pri montaži je treba nositi rokavice, da se preprečijo poškodbe zaradi zmečkanih ali urezov.
- ⚠ Ta izdelek se sme uporabljati le z namenom umivanja, vzdrževanja higiene in telesne nege.
- ⚠ Otroci kot tudi odrasle osebe z omejenimi telesnimi, duševnimi in/ali senzoričnimi sposobnostmi ne smejo nenadzorovano uporabljati tega izdelka. Osebe, ki so pod vplivom alkohola ali drog, tega izdelka ne smejo uporabljati.
- ⚠ Izogibati se je treba stiku prhalnega curka z občutljivimi deli telesa (npr. očmi). Med telesom in prho mora biti vedno zadosten razmik.
- ⚠ Velike razlike v tlaku med priključkom za mrzlo in priključkom za toplo vodo je potrebno izravnati.

### ⚡ Električni priključek

- ⚠ Električno priključitev sme izvesti le elektrostrokovnjak!
- ⚠ Napajanje 100-240V/N/PE/50-60Hz (dolžina: 0,3 m) predhodno instalirajte.
- ⚠ Zaščita se mora izvesti preko zaščitnega tokovnega stikala (RCD/ FI) z izračunanim diferenčnim tokom  $\leq 30$  mA.
- ⚠ Izdelek mora biti priključen na potencialno izravnavo (PA) 4 mm<sup>2</sup> na lokaciji.

### ⚡ Elektroinštalater

- ⚠ Instalacijo in preizkuse mora izvesti pooblaščen elektro strokovnjak, pri čemer mora upoštevati VDE 0100 Del 701, IEC 60364-6 in IEC 60364-7-701 ter EN 60335-2-105.
- ⚠ Omrežni priključni kabel je treba dvojno izoliran  vstaviti v priključno dozo.

## Navodila za montažo

- Pred montažo je treba izdelek preveriti glede morebitnih transportnih poškodb. Po vgradnji transportne ali površinske poškodbe ne bodo več priznane.
- Cevi in armaturo je treba montirati, izprati in preveriti po veljavnih standardih.
- Upoštevati je treba pravilnike o inštalacijah, ki veljajo v posamezni državi.
- Pri montaži tega proizvoda s strani kvalificiranega strokovnega osebja je treba paziti na to, da je pritrdilna ploskev na celotni površini za pritrditev gladka (brez izstopajočih fug ali zasekov ploščic), da je struktura stene primerna za montažo































proizvoda in ne kaže šibkih mest.

- Pri vrtnanju bodite pozorni na električne vodnike in vodovodno napeljavo
- Zmogljivost odtoka mora biti ustrezne velikosti.
- Prha se sme priključiti le za zapornim ventilom ali sanitarno armaturo.

## Tehnični podatki

Obratovalni tlak pred armaturo:	maks. 1 MPa
Priporočeni delovni tlak:	0,3 - 0,5 MPa
(1 MPa = 10 bar = 147 PSI)	
Temperatura tople vode:	maks. 60 °C
Priporočena temperatura tople vode:	42 °C
Varnostna blokada:	40 °C
<b>Opozorilo: prekoračitev te temperature lahko povzroči opekline!</b>	
Termična dezinfekcija:	maks. 70 °C / 4 min
Nazivna napetost	100-240V AC 50-60Hz
Nazivna poraba	18 W
Svetilke 4 x LED:	12V DC SELV 4 W
Svetilka nima možnosti uravnavanja zatemnitve.	
Razred zaščite	II
Vrsta zaščite	IPX5

## Opis simbola

	Ne smete uporabiti silikona, ki vsebuje osetno kislino!		Vodni priključek DN20		Prazna cev za napajanje
	<b>Mere</b> (glejte stran 32)		Topla voda		Opozorilo pred vročo površino!
	<b>Primeri montaže</b> (glejte stran 34)		Vodni priključek DN20		Nosite zaščitne rokavice
	<b>Upravljanje</b> (glejte stran 31)		Mrzla voda		Nosite zaščito za oči
	<b>Rezervni deli</b> (glejte stran 31)		Podometni ventil		<b>Naravna gobica</b>
	<b>Servisni Zamenjava svetilke</b> (glejte stran 52)		Quattro 4tiripotna prestavitev		<b>Odstranjevalec apnenca</b> (na osnovi citronske kisline)
	<b>Čiščenje</b> (glejte stran 50) in priložena brošura		Trio Universal zaporni in preklonni ventil		Izogibajte se stiku z očmi in kožo. Če proizvod pride v oči, jih temeljito sperite z vodo.
	<b>Elektroinštalater</b>		HighFlow Termostat		Tok vklop / izklop
	<b>Vzdrževanje</b> (glejte stran 53)		! Odtočna kapacitetamora znašati več kot 50 l/min.		<b>Preskusni znak</b> (glejte stran 54)
	Funkcije varnostnih priprav je treba po DIN EN 1717 redno preverjati v skladu z nacionalnimi ali regionalnimi predpisi (DIN 1988 enkrat letno).		> 50 l/min Odtok		
			Raindrain Sredina pršne kadi		
			X Odprite vodo / Zaprite vodo.		



**Montaža Osnovni komplet glejte stran 42**



**Montaža Zaključna garnitura glejte stran 47**



## Ohutusjuhised

- △ Kandke paigaldamisel muljumis- ja löikevigastuste vältimiseks kindaid.
- △ Toodet tohib kasutada ainult pesemis-, hügieeni- ja kehapihustamisesmärkidel.
- △ Lapsed, samuti kehaliste, vaimsete või tajupiirangutega täiskasvanud ei tohi dušisüsteemi järelvalveta kasutada. Alkoholi või narkootikumide mõju all olevad isikud ei tohi dušisüsteemi kasutada.
- △ Duši veejoad ei tohi kokku puutuda tundlike kehaosadega (nt silmad). Jätke duši ja keha vahele piisav vahe.
- △ Kui külma ja kuumu vee ühenduste surve on väga erinev, tuleb need tasakaalustada.

## Elektriühendus

- △ Elektriühenduse peab läbi viima väljaõppinud elektrik!
- △ Eelpaigaldage pingega varustamine 100-240V/N/PE/50-60Hz (pikkus: 0,3 m).
- △ Kaitse peab toimuma rikkevoolu kaitseseadisega (RCD/FI) nominaal-jääkvooluga  $\leq 30$  mA.
- △ Toode tuleb ühendada kohapeal olemasoleva potentsiaalühitlustusega (PA) 4 mm<sup>2</sup>.

## Elektrimontöör

- △ Paigaldustööd ja kontroll laske viia läbi sertifitseeritud spetsialistil vastavalt VDE 0100 osa 701, IEC 60364-6 ja IEC 60364-7-701 ning EN 60335-2-105 eeskirjadele.
- △ Võrgujuhe tuleb juhtida topeltisolatsiooniga  ühen use pistikupessa.

## Paigaldamisjuhised

- Enne paigaldamist tuleb toodet kontrollida transpordikahjustuste osas. Pärast paigaldamist ei tunnustata enam transpordi- või pinnakahjustuste kaebuseid.
- Voolikute ja segisti paigaldamisel, loputamisel ja kontrollimisel tuleb lähtuda kehtivatest normatiividest.
- Vastavas riigis kehtivaid paigalduseeskirju tuleb järgida.
- Toote paigaldamisel kvalifitseeritud spetsialistide poolt tuleb jälgida, et kinnituspind oleks kogu ulatuses ühtlaselt tasane (mitte ühki üleseisvat vuuki või kaldus kahhelkivi), seina ülesehitus toote paigaldamiseks sobiv ja ilma nõrkade































kohtadeta.

- Arvestage puurimisel voolukaablite ja veejuhtmete asukohaga
- Äravoolu jõudlus peab olema piisav.
- Duši tohib ühendada ainult sulgurkraani või sanitaaramatuuri järele.

## Tehnilised andmed

töörõhk süsteemis enne duši:	maks. 1 MPa
Soovitav töörõhk:	0,3 - 0,5 MPa
(1 MPa = 10 baari = 147 PSI)	
Kuuma vee temperatuur:	maks. 60°C
Soovitav kuumu vee temperatuur:	42°C
Kaitselukk:	40°C
<b>Hoiatus: selle temperatuuri ületamisel võivad tekkida põletused!</b>	
Termiline desinfitatsioon:	maks. 70°C / 4 min
Nimipinge	100-240V AC 50-60Hz
Nimisisend	18 W
Valgustid 4 x LED:	12V DC SELV 4 W
Valgustit ei saa hämardada.	
Kaitseklass	II
Kaitseklass	IPX5

## Sümbolite kirjeldus

	Ärge kasutage äädikhapet sisaldavat silikooni!		Veeühendus DN20		elektrivarustus juhtmestiku paigaldus
	<b>Mõõtude</b> (vt lk 32)		Soe vesi		Kuum pealispind!
	<b>Paigalduse näited</b> (vt lk 34)		Veeühendus DN20		Kandke kaitsekindaid
	<b>Kasutamine</b> (vt lk 31)		Külm vesi		Kandke kaitseprille
	<b>Varuosad</b> (vt lk 31)		peiteklapp		
	<b>Varuos Lambi vahetamine</b> (vt lk 52)		Quattro-liitmik		<b>Looduslik svamm</b>
	<b>Puhastamine</b> (vt lk 50) ja kaasas-olev brošüür		Quattro		<b>Katlakivi eemaldaja</b> (põhineb sidrunhappel)
	<b>Elektrimontöör</b>		Trio		Vältige kokkupuudet silmade ja nahaga. Kui toode satub silma, siis loputage silmi hoolikalt veega..
	<b>Hooldus</b> (vt lk 53)		HighFlow		Elektrivool sees / väljas
	Ohutusseadeldiste toimimist tuleb regulaarselt kontrollida, vastavalt standardile DIN EN 1717 riiklike või piirkondlike määrustega kooskõlas kontrollida (standardi DIN 1988 puhul üks kord aastas).		> 50 l/min		<b>Kontrollsertifikaat</b> (vt lk 54)
			Raindrain		
			X		
			Keerake vesi lahti / Keerake vesi kinni		



### Paigaldamine põhikomplekt vt lk 42



### Paigaldamine Valmiskomplekt vt lk 47





## Drošības norādes

- ⚠ Montāžas laikā, lai izvairītos no saspiedumiem un iegriezumiem, nepieciešams nēsāt cimdus.
- ⚠ Šo produktu drīkst izmantot tikai, lai mazgātos, higiēnai un ķermeņa tīrīšanai.
- ⚠ Bērni, kā arī pieaugušie ar fiziskiem, garīgiem un / vai sensoriskiem ierobežojumiem nedrīkst lietot šo produktu bez uzraudzības. Personas, kas atrodas alkohola vai narkotisko vielu iespaidā, nedrīkst lietot šo dušas sistēmu.
- ⚠ Nepieciešams izvairīties no dušas strūkļas tieša kontakta ar jutīgām ķermeņa daļām (piem., acīm). Nepieciešams ievērot pietiekošu attālumu starp dušu un ķermeni.
- ⚠ Jāizlīdzina spiediena atšķirības starp aukstā un karstā ūdens pievadiem.

### Elektroapgādes pieslēgvietā

- ⚠ Elektrisko pieslēgumu drīkst veikt tikai elektriķis!
- ⚠ Barošanas bloku 100-240V/N/PE/50-60Hz (garums: 0,3 m) instalēt iepriekš.
- ⚠ Jānodrošina noplūdes strāvas aizsargsistēma (RCD/ FI) ar izmērīto strāvas starpību ≤ 30 mA.
- ⚠ Izstrādājums jāpieslēdz pasūtītāja paredzētajam potenciālu izlīdzinātājam (PA) 4 mm<sup>2</sup>.

### Elektromontieris

- ⚠ Instalācijas un pārbaudes darbus jāveic sertificētam speciālistam saskaņā ar DIN VDE 0100 701. d., IEC 60364-6, IEC 60364-7-701 un EN 60335-2-105.
- ⚠ Tīkla pieslēgšanas vads jāievada pieslēgšanas rozetē r dubultu izolāciju .

## Norādījumi montāžai

- Pirms montāžas nepieciešams pārbaudīt, vai produktam transportēšanas laikā nav radušies bojājumi. Pēc iebūvēšanas bojājumi, kas radušies transportēšanas laikā, vai virsmas bojājumi netiek atzīti.
- Cauruļvadi un armatūra ir jāuzstāda, jāizskalo un jāpārbauda saskaņā ar spēkā esošajiem standartiem.
- Jāievēro attiecīgās valsts spēkā esošās montāžas prasības.
- Kvalificētiem speciālistiem, montējot produktu, jāpiegriež vērība tam, lai piestiprināšanas virsma visā piestiprināšanas zonā ir gluda (nav fūgu vai flīžu iecirtumu),

sienas uzbūve ir piemērota produkta montāžai un tajā nav nestabilu vietu.

- Urbjot pievērsiet uzmanību elektrības un ūdens vadiem!
- Noplūdei jānodrošina pietiekama ūdens caurplūde.
- Dušu drīkst pieslēgt tikai aiz noslēgšanas vārsta vai sanitāras armatūras.

## Tehniskie dati

Darba spiediens pirms jaucējkrāna:	maks. 1 MPa
leteicamais darba spiediens:	0,3 - 0,5 MPa
(1 MPa = 10 bar = 147 PSI)	
Karstā ūdens temperatūra:	maks. 60°C
leteicamā karstā ūdens temperatūra:	42°C
droša temperatūra	40°C
<b>Brīdinājums: šīs temperatūras pārsniegšana var izraisīt applaucēšanos!</b>	
Termiskā dezinfekcija :	maks. 70°C / 4 min
Nominālais spriegums	100-240V AC 50-60Hz
nominālais patēriņš	18 W
Gaismekļi 4 x LED:	12V DC SELV 4 W
Lampas spilgtums nav regulējams.	
Aizsardzības klase	II
Aizsardzības līmenis	IPX5

## Simbolu nozīme

Neizmantot silikonu, kas satur etiķskābi!	Ūdensvada pieslēgvietā DN20	Caurule strāvas padevei
<b>Izmērus</b> (skat. lpp. 32)	Siltais ūdens	Brīdinājums par karstu virsmu!
<b>Montāžas piemēri</b> (skat. lpp. 34)	Ūdensvada pieslēgvietā DN20	Valkāt aizsargcimdus
<b>Lietošana</b> (skat. lpp. 31)	Aukstais ūdens	Valkāt acu aizsargus
<b>Rezerves daļas</b> (skat. lpp. 31)	Zemapmetuma ventils	<b>Dabīgais sūklis</b>
<b>Apkopes Apgaismes ķermeņa nomaiņa</b> (skat. lpp. 52)	Četrvirzienu pārslēgs	<b>Atkalķotājs</b> (uz citronskābes bāzes)
<b>Tīrīšana</b> (skat. lpp. 50) un klāt pievienotais buklets	<b>Quattro</b>	Novērst nokļūšanu acīs un uz ādas. Ja produkts iekļūst acīs, tās kārtīgi jāskalo ar ūdeni.
<b>Elektromontieris</b>	<b>Trio</b>	Strāva ieslēgta / izslēgta
<b>Apkope</b> (skat. lpp. 53)	<b>High Flow</b>	<b>Pārbaudes zīme</b> (skat. lpp. 54)
Drošības iestatījumu funkcionalitāte ir jāpārbauda regulāri atbilstoši DIN EN 1717 un saskaņā ar valsts vai reģionālajiem noteikumiem (saskaņā ar DIN 1988 vienreiz gadā).	Noteces veiktspējai jābūt vairāk nekā 50 l/min.	
	Notece	
	<b>Raindrain X</b>	
	Dušas paliktna vidus	
	Atgrieziet ūdeni / Noslēgt ūdeni	

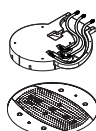

**Montāža Pamatkomplekts skat. lpp. 42**



**Montāža Komplekts skat. lpp. 47**



## Sigurnosne napomene

- ⚠ Prilikom montaže se radi sprečavanja prignječenja i posekotina moraju nositi rukavice.
- ⚠ Proizvod sme da se koristi samo za kupanje, tuširanje i ličnu higijenu.
- ⚠ Deca, kao i telesno, mentalno i/ili senzorno hendikepirane odrasle osobe ne smeju da koriste proizvod bez nadzora. Osobe koje su pod uticajem alkohola ili droga ne smeju da koriste proizvod.
- ⚠ Mora se izbegavati kontakt mlaza iz tuša sa osetljivim delovima tela (npr. očima). Telo korisnika mora biti na dovoljnom odstojanju od tuša.
- ⚠ Velika razlika u pritisku između vruće i hladne vode mora biti izbalansirana.

## ⚡ Električni priključak

- ⚠ Električnu sme priključiti samo ovlašćeni električar!
- ⚠ Prethodno priključite naponsko napajanje 100-240V/N/PE/50-60Hz (dužina: 0,3 m).
- ⚠ Vod se mora osigurati nadstrujnom zaštitnom sklopkom (RCD/FI) s nazivnom diferencijalnom strujom  $\leq 30$  mA.
- ⚠ Proizvod mora da se priključi na postojeće izjednačenje potencijala (PA) 4 mm<sup>2</sup>.

## ⚡ elektroinstalater

- ⚠ Instalaciju i ispitivanje smeju obavljati isključivo sertifikovani električari uz uvažavanje odredaba VDE 0100 deo 701, IEC 60364-6 i IEC 60364-7-701 kao i EN 60335-2-105.
- ⚠ Strujni priključni kabl mora da se dvostruko izoliran  uvede u utičnicu.

## Instrukcije za montažu

- Pre montaže se mora proveriti da li je proizvod oštećen pri transportu. Nakon ugradnje se ne priznaju nikakve reklamacije koje se odnose na površinska i transportna oštećenja.
- Vodovi i armatura moraju biti postavljeni, isprani i testirani prema važećim normama.
- Treba se pridržavati propisa koji u određenim zemljama važe za instalacije.
- Kada proizvod montira kvalifikovano stručno osoblje treba paziti da čitava površina na koju se učvršćuje bude ravna (bez istaknutih fuga ili krivljenja

pločica), da je zidna konstrukcija primerena montaži proizvoda i da nema slabih mesta.

- Prilikom bušenja treba paziti na električne kablove i vodovodne cevi!
- Mora se predvideti dovoljan kapacitet odvoda.
- Tuš se sme priključivati samo iza ventila za zatvaranje ili iza sanitarne armature.































## Tehnički podaci

Radni pritisak ispred armature:	maks. 1 MPa
Preporučeni radni pritisak:	0,3 - 0,5 MPa
(1 MPa = 10 bar = 147 PSI)	
Temperatura vruće vode:	maks. 60°C
Preporučena temperatura vruće vode:	42°C
Sigurnosni prekid:	40°C

## Upozorenje: Prekoračenje ove temperature može da izazove opekotine!

Termička dezinfekcija:	maks. 70°C / 4 min
Nominalni napon	100-240V AC 50-60Hz
Nominalna potrošnja	18 W
Svetiljke 4 x LED:	12V DC SELV 4 W
Sijalica nije prigušiva.	
Klasa zaštite	II
Klasa zaštite	IPX5

## Opis simbola

	Nemojte koristiti silikon koji sadrži sirćetnu kiselinu!		priključak za vodu DN20		Šuplja cev za električno napajanje
	<b>Mere</b> (vidi stranu 32)		Topla voda		Upozorenje na opasnost od vrela površine!
	<b>Primeri montaže</b> (vidi stranu 34)		priključak za vodu DN20		Nosite zaštitne rukavice
	<b>Rukovanje</b> (vidi stranu 31)		Hladna voda		Nosite zaštitne naočare
	<b>Rezervni delovi</b> (vidi stranu 31)		Uzidni ventil		<b>prirodni sunder</b>
	<b>Servisni Zamena svetiljki</b> (vidi stranu 52)		Quattro četverostruki preusmerivač		<b>Sredstvo za uklanjanje kamena</b> (na bazi limunske kiseline)
	<b>Čišćenje</b> (vidi stranu 50) i priložena brošura		Trio Universal ventil za zatvaranje i preklopni ventil		Izbegavajte kontakt sa očima i kožom. U slučaju kontakta sa očima, dobro isperite sa dosta vode.
	<b>elektroinstalater</b>		Trio HighFlow Termostat HighFlow		Struja uklj. / isklj.
	<b>Održavanje</b> (vidi stranu 53)		Kapacitet odvoda mora biti veći od 50 l/min.		<b>Ispitni znak</b> (vidi stranu 54)
	Isppravno funkcionisanje bezbednosnih elemenata se mora redovno proveravati prema standardu DIN EN 1717 i u skladu s važećim nacionalnim ili regionalnim propisima (DIN 1988 jednom godišnje).		Ispust		
			Raindrain Sredina tuš-kada		
			X Otvorite dotok vode / Zatvorite dotok vode		



**Montaža osnovna garnitura vidi stranu 42**



**Montaža Završni set vidi stranu 47**



## Sikkerhetshenvisninger

- ⚠ Bruk hansker under montasjen for å unngå klem- og kuttskader.
- ⚠ Produktet skal kun brukes for bade-, hygiene- og kroppshygiene.
- ⚠ Barn og voksne med fysiske og psykiske og/eller sensoriske handicap skal ikke bruke dusjsystemet uten oppsyn. Personer som er påvirket av alkohol eller narkotika skal ikke bruke dusjsystemet.
- ⚠ Dusjstrålen skal ikke komme i kontakt med ømfintlige kroppsdeler (f.eks. øyene). Overhold en tilstrekkelig avstand mellom dusjen og kroppen.
- ⚠ Store trykkdifferanser mellom kaldt- og varmtvannstilkoblinger skal utlignes.

### ⚡ El-tilkoblinger

- ⚠ El-tilkoblinger skal kun utføres av el-fagfolk!
- ⚠ Installer strømtilførsel 100-240V/N/PE/50-60Hz (lengde: 0,3 m) på forhånd.
- ⚠ Installasjonen skal sikres ved hjelp av en jordfeilbryter (RCD/FI) dimensjonert for en reststrøm på  $\leq 30$  mA.
- ⚠ Produktet må tilkobles en 4 mm<sup>2</sup> potensialutjevning (PA).

### ⚡ El-installatør

- ⚠ Installasjons- og kontrollarbeid skal utføres av en godkjent el-fagbedrift som overholder direktiv VDE 0100 del 701, IEC 60364-6 og IEC 60364-7-70101. samt EN 60335-2-105.
- ⚠ Strømforsyningsledningen må være dobbelt isolert , og settes inn i stikkontakten.

## Montagehenvisninger





























- Før montasjen skal produktet sjekkes for transportskader. Etter monteringen aksepteres ikke noen transport- eller overflateskader.
- Ledningene og armaturen skal monteres, spyles og sjekkes iht. de gyldige normer.
- Gjeldende retningslinjer for rørleggerarbeid i de enkelte land skal følges.
- Under monteringen av produktet gjort av kvalifisert fagperson, skal man påse at monteringsoverflaten på hele festeområdet er plant (ingen utstikkende fuger eller flisekanter), at veggoppbyggingen egner seg for produktmontasjen og ikke viser svake punkter.

- Ved boring skal det passes på strøm- og vannledninger!
- Utløpsytelsen skal være tilstrekkelig dimensjonert.
- Dusjen skal kun monteres etter en avstengingsventil eller etter sanitærarmatur.

## Tekniske data

Driftstrykk før armatur:	maks. 1 MPa
Anbefalt driftstrykk:	0,3 - 0,5 MPa
(1 MPa = 10 bar = 147 PSI)	
Varmtvannstemperatur	maks. 60°C
Anbefalt temperatur for varmt vann	42°C
Sikkerhetssperre	40°C
<b>Varselshenvisning: Overskridelse av denne temperaturen kan medføre forbrenninger!</b>	
Termisk desinfisering:	maks. 70°C / 4 min
Nominell spenning	100-240V AC 50-60Hz
Lamper 4 x LED:	18 W
Lyspæren kan ikke dimmes.	12V DC SELV 4 W
Beskyttelsesklasse	II
Beskyttelsesklasse	IPX5

## Symbolbeskrivelse

	Ikke bruk silikon som inneholder eddiksyre!		Vanntilkobling DN20		Tomme rør for strømforsyning
	<b>Mål</b> (se side 32)		Varmtvann		Varsel pga. het overflate!
	<b>Montasje-eksempel</b> (se side 34)		Vanntilkobling DN20		Bruk vernehansker
	<b>Betjening</b> (se side 31)		Kaldtvann		Bruk vernebriller
	<b>Service-deler</b> (se side 31)		Innfelt ventil		<b>Natursvamp</b>
	<b>Service Bytte lysmiddel</b> (se side 52)		Quattro fire-veis omstilling		<b>Avkalker</b> (sitronsyrebaset)
	<b>Rengjøring</b> (se side 50) og vedlagt brosjyre		Trio universal stenge- og omstillingsventil		Unngå øye- og hudkontakt. Hvis produktet skulle komme i kontakt med øynene, skyll dem grundig med vann.
	<b>El-installatør</b>		Trio HighFlow		
	<b>Vedlikehold</b> (se side 53)		Termostat HighFlow		
	Funksjonen til sikkerhetsinnretninger skal kontrolleres iht. DIN EN 1717 og i samsvar med de nasjonale og lokale forskrifter, sjekkes regelmessig (DIN 1988 en gang i året).		Avløp ytelse skal være mer enn 50 l/min.		
			Avløp		Strøm på / av
			Raindrain		<b>Prøvemerket</b> (se side 54)
			X		
			Vann settes på / Slå av vann		

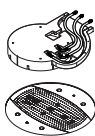

**Montasje Basissett se side 42**

**Montasje Ferdigsett se side 47**



## Указания за безопасност

- ⚠ При монтажа трябва да се носят ръкавици, за да се избегнат наранявания поради притискане или порязване.
- ⚠ Позволено е използването на продукта само за къпане, хигиена и цели на почистване на тялото.
- ⚠ Не е позволено деца, както и възрастни с физически, умствени и / или сензорни ограничения да използват продукта без надзор. Не е позволено използването на системата на продукта от лица, употребили алкохол или дрога.
- ⚠ Трябва да се избягва контакта на струите на разпръсквателя с чувствителни части на тялото (напр. очите). Между разпръсквателя и тялото трябва да се спазва достатъчно разстояние.
- ⚠ Големите разлики в налягането между изводите за студената и топлата вода трябва да се изравняват.

## ⚡ Свързване към електричеството

- ⚠ Свързването към електричество се позволява само от електротехник!
- ⚠ Захранването с напрежение 100-240V/N/PE/50-60Hz (дължина: 0,3 m) се инсталира предварително.
- ⚠ Защитата трябва да се осъществи с предпазен шалтер за остатъчен ток (RCD/ FI) с параметриран диференциален ток  $\leq 30$  mA.
- ⚠ Продуктът трябва да бъде свързан към налично при инвеститора изравняване на потенциала (PA) 4 mm<sup>2</sup>.

## ⚡ Електромонтьор

- ⚠ Дейностите по инсталацията и инспекцията следва да бъдат изпълнявани от оторизиран електротехник при спазване на VDE 0100 Част 701, IEC 60364-6 и IEC 60364-7-701 както и на EN 60335-2-105.
- ⚠ Кабелът за свързване към мрежата трябва да бъде вкара в двойно изолиран  в присъединителната кутия.

## Указания за монтаж

- Преди монтажа продуктът трябва да се провери за транспортни щети. След монтажа не се признават транспортни или повърхностни щети.
- Тръбопроводите и арматурата трябва да се монтират, промият и проверят в

съответствие с валидните норми.

- Трябва да бъдат спазвани валидните в съответните страни предписания за инсталиране.
- При монтаж на продукта от квалифицирани специалисти да се внимава за това, закрепващата повърхност в целия диапазон на закрепването да бъде равна (без изпъкнали фуги или изместване на плочки), конструкцията на стената да е подходяща за монтаж на продукта и да няма слаби места.
- При пробиването внимавайте за електро- и водопроводите!
- Трябва да се изчисли достатъчна мощност на изтичане.
- Разпръсквателят може да се свърже само след спирачен клапан или санитарна арматура.

## Технически данни

Работно налягане преди арматурата:	макс. 1 МПа
Препоръчително работно налягане: (1 МПа = 10 bar = 147 PSI)	0,3 - 0,5 МПа
Температура на горещата вода:	макс. 60 °C
Препоръчителна температура на горещата вода:	42 °C
Предпазна блокировка:	40 °C
<b>Предупредително указание: Надвишаването на температурата може да доведе до изгаряния!</b>	
Термична дезинфекция:	макс. 70 °C / 4 мин
Номинално напрежение	100-240V AC 50-60Hz
Номинална консумируема мощност	18 W
Лампи 4 x LED:	12V DC SELV 4 W
Яркостта на осветителното тяло не може да се регулира.	
Защитен клас	II
Вид защита	IPX5

## Описание на символите

	Не използвайте силикон, съдържащ оцетна киселина!		Извод за вода DN20		Тръба за полагане на кабели за електрозахранване
	<b>Размери</b> (вижте стр. 32)		Топла вода		Предупреждение за гореща повърхност!
	<b>Примери за монтаж</b> (вижте стр. 34)		Извод за вода DN20		Носете защитни ръкавици
	<b>Обслужване</b> (вижте стр. 31)		Студена вода		Носете защита за очите
	<b>Сервизни части</b> (вижте стр. 31)		Клапан за мазилка		<b>Естествен сунгер</b>
	<b>Сервиз Смяна на осветителното тяло</b> (вижте стр. 52)		Четирипътно превключване Quattro		<b>Препарат за почистване на варовик</b> (на базата на лимонова киселина)
	<b>Почистване</b> (вижте стр. 50) и приложена брошура		Спирателен и превключващ клапан Trio Universal		Избягвайте контакт с очите и кожата. Ако продуктът попадне в очите Ви, изплакнете ги добре с вода.
	<b>Електромонтьор</b>		Термостат HighFlow		Електричество вкл / изкл
	<b>Поддръжка</b> (вижте стр. 53)		Мощността на изтичане трябва да бъде повече от 50 л/мин.		<b>Контролен знак</b> (вижте стр. 54)
	Съгласно DIN EN 1717 функционирането на предпазните приспособления трябва да се проверява на редовно в съответствие с националните или регионални изисквания (DIN 1988 веднъж годишно).		Отвеждане		
			Среда на коритото на душ-кабината		
			Включване на водата / Изключване на водата		



**Монтаж Основен набор вижте стр. 42**



**Монтаж Готов набор вижте стр. 47**



## Udhëzime sigurie

- ⚠ Për të evituar lëndimet e pickimeve ose të prerjeve gjatë procesit të montimit duhet që të vishni doreza.
- ⚠ Produkti duhet të përdoret vetëm qëllimet e banjave, të higjienës dhe të larjes së trupit.
- ⚠ Fëmijët dhe të rriturit me aftësi të kufizuara fizike, mendore dhe/ose ndijuese nuk duhet ta përdorin produktin pa qenë nën mbikëqyrje. Personat që janë nën ndikimin e drogave ose të alkoolit nuk duhet ta përdorin produktin.
- ⚠ Kontakti i valëve të dushit me pjesët e ndjeshme të trupit (p.sh. me sytë) duhet që të shmanget. Midis dushit dhe trupit duhet që të mbahet një distancë e mjaftueshme.
- ⚠ Ndryshimet e mëdha të presionit mes lidhjeve të ujit të ftohtë dhe atij të ngrohtë duhen ekuilibruar.

### Lidhja me rrjetin elektrik

- ⚠ Lidhjet elektrike mund të bëhen vetëm nga elektricisti i specializuar.
- ⚠ Instaloni më parë furnizimin me energji elektrike 100-240V/N/PE/50-60Hz (Gjatësia: 0,3 m).
- ⚠ Sigurimi duhet të kryhet nëpërmjet një pajisjeje mbrojtëse kundër rrjedhjes së rrymës (RCD/ FI) me një vlerësim të rrymës diferenciale  $\leq 30\text{mA}$ .
- ⚠ Produkti duhet të lidhet në një barazues ekzistues potenciale (PA) 4 mm<sup>2</sup>.

### Elektricisti

- ⚠ Punimet e instalimit dhe të kontrollit duhet të realizohen nga një elektricist i autorizuar duke marrë parasysh VDE 0100 Pjesa 701, IEC 60364-6 dhe IEC 60364-7-701 si dhe EN 60335-2-105.
- ⚠ Linja e lidhjes me rrjetin elektrik duhet të jetë dyf sh e izoluar e futur në kutinë e lidhjes.

## Udhëzime për montimin

- Përpara montimit duhet që produkti të kontrollohet për dëmtime nga transporti. Pas instalimit nuk do të njihet asnjë dëmtim nga transporti ose dëmtim i sipërfaqes.
- Tubacionet dhe rubinetet duhet që të montohen, të shpëlahen dhe të kontrollohen

sipas standardeve në fuqi

- Duhet të respektohen linjat udhëzuese të instalimit, të vlefshme për vendet respektive.
- Gjatë montimit të produktit nga teknikët e specializuar duhet mbajtur parasysh që sipërfaqja e montimit gjendet brenda zonës së përgjithshme të planit të montimit (nuk ka vendbashkime të dala ose mospërputhje të pllakave), që struktura e murit është e përshtatshme për montimin e produktit dhe që nuk paraqet asnjë pikë të dobët.
- Gjatë shpimit bëni kujdes për të gjitha linjat elektrike dhe tubacionet e ujit!
- Kapaciteti i rrjedhjes duhet dimensionuar në mënyrë të mjaftueshme.
- Dushi duhet të jetë i lidhur/montuar vetëm pas një ventili (valvule) bllokuese ose pajisjeje sanitare.

## Të dhëna teknike

Shtypja para armaturës:	maks. 1 MPa
Presioni i rekomanduar:	0,3 - 0,5 MPa
(1 MPa = 10 bar = 147 PSI)	
Temperatura e ujit të ngrohtë	maks. 60 °C
Temperatura e rekomanduar e ujit të ngrohtë:	42 °C
Bllokada e sigurisë	40 °C
<b>Paralajmërim Tejkalimi i kësaj temperature mund të shkaktojë dëgjie!</b>	
Dezinfektim Termik:	maks. 70 °C / 4 min
Tensioni nominal	100-240V AC 50-60Hz
Konsumi i punës	18 W
Ndriçuesit 4 x LED:	12V DC SELV 4 W
Mjeti ndriçues nuk është i kontrollueshëm.	
Klasa e mbrojtjes	II
Lloji i mbrojtjes	IPX5

## Përshkrimi i simbolit

Mos përdorni silikon që në përbërje ka acid acetik.	Lidhja me rrjetin e ujit DN20	Tubi bosh për furnizimin me energji elektrike
<b>Përmasat</b> (shih faqen 32)	Uji i ngrohtë	Paralajmërimi për sipërfaqen e nxehtë!
<b>Shembuj të montimit</b> (shih faqen 34)	Lidhja me rrjetin e ujit DN20	Vendosni doreza mbrojtëse
<b>Përdorimi</b> (shih faqen 31)	Uji i ftohtë	Vendosni mbrojtëse për sytë
<b>Pjesët e servisit</b> (shih faqen 31)	Ventili i suvajës	<b>Sfungjer natyral</b>
<b>Servisi Ndërrimi i llambës</b> (shih faqen 52)	Valvul devijuese Quattro me katër drejtime	<b>Largues bigorri</b> (me bazë acidi citrik)
<b>Pastrimi</b> (shih faqen 50) dhe broshura bashkëngjitur	Valvul universale Trio për bllokim dhe devijim	Shmangni kontaktin me sytë dhe lëkurën. Nëse produkti bie në kontakt me sytë, shpëlaheni ato mirë me ujë të bollshëm.
<b>Elektricisti</b>	<b>Trio High Flow</b>	Korrenti kyçur / shkyçur
<b>Mirëmbajtja</b> (shih faqen 53)	Kapaciteti i shkarkimit duhet të jetë më shumë se 50 l/min.	<b>Shenja e kontrollit</b> (shih faqen 54)
Pajisjet në shërbim të sigurisë duhen kontrolluar rregullisht në bazë të normave DIN EN 1717 konform normave nacionale dhe regionale (DIN 1988 një herë në vit).	<b>&gt; 50 l/min</b>	
	<b>Raindrain X</b>	
	Hapni ujin / Mbyllni ujin.	

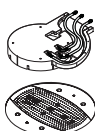

**Montimi Komplet bazë shih faqen 42**



**Montimi Komplet i gatshëm shih faqen 47**



## تنبيهات الأمان

- عند التركيب بواسطة عمال تركيب متخصصين يجب الإنتباه إلى أن مساحة التثبيت في مكان التركيب بوجه عام مسطحة (لا توجد روابط أو فروق للربط بين البلاطات). لذا يجب التأكد من أن الحائط الذي سيتم تركيب المنتج عليه صالح لذلك وأنه لا يوجد به نقاط ضعف.
- يجب الحذر عند الثقب فوق وصلات كهرباء أو مياه!
- يجب أن يكون الأداء من حيث حجز الفضلات ذا حجم مناسب.
- يسمح بتوصيل الدش فقط بعد صمام حبس الماء أو بعد خلط الماء.

## المواصفات الفنية

الحد الأقصى 1 ميجاباسكال	ضغط التشغيل على تجهيزات الدش:
0,3 - 0,5 ميجاباسكال	ضغط التشغيل الموصى به:
	(1 ميجاباسكال = 10 بار = 147 PSI)
الحد الأقصى 60°C	درجة حرارة الماء الساخن:
42°C	درجة الحرارة الموصى بها للماء الساخن:
40°C	حفظ أمان
	<b>تحذير: يمكن أن يؤدي تخطي درجة الحرارة هذه إلى إحتراقات!</b>
الحد الأقصى 4 / 70°C الدقيقة	تقييم حراري:
100-240V AC 50-60Hz	الجهد الاسمي
18 W	الاستهلاك الاسمي
12V DC SELV 4 W	المصابيح 4 LED x:
	مصباح الإنارة ليس عاكس للضوء.
	فئة الحماية
	نوع الحماية

II  
IPX5

⚠ يجب ارتداء قفازات لليد أثناء التركيب لتجنب حدوث أخطار الإنحشار أو الجروح.

⚠ لا يجب استخدام المنتج إلا في أغراض الاستحمام والأغراض الصحية وأغراض تنظيف الجسم.

⚠ لا يسمح لأي أطفال أو أفراد بالغين يعانون من إعاقات بدنية أو ذهنية أو حسية أو يعانون من جميع هذه الإعاقات باستخدام المنتج إلا تحت إشراف آخرين. كما أنه لا يسمح لأي شخص تحت تأثير تناول الكحول أو المخدرات باستخدام نظام الدش.

⚠ يجب تجنب حدوث إتصال مباشر بين الماء الخارج من رأس الدش وبين أجزاء الجسم الحساسة (مثل العينين). يجب وجود مسافة كافية بين رأس الدش والجسم.

⚠ يجب أن يكون تيار الماء الساخن والماء البارد متعادلين في الضغط.

## ⚡ توصيلة كهربائية

⚠ لا يجوز القيام بالتوصيلات الكهربائية إلا عن طريق فني كهرباء متخصص!

⚠ يتم التركيب المسبق لخطوط إمدادات الطاقة 100-240V/N/PE/50-60Hz (طول: 0,3م).

⚠ يتم التأمين من خلال تجهيزة حماية ضد اختلاف التيار (RCD/ FI) عند اختلاف التيار لأقل من أو يساوي 30 مللي أمبير.

⚠ يجب أن يكون المنتج موصلاً بموصل ربط متساوي الجهد (PA) متاحاً في الموقع 4/باسكال/ ميللي متر مربع.

## ⚡ مختص تركيب الإلكترونيات

⚠ يتعين القيام بكافة أعمال التركيب والفحص من قبل فني كهرباء معتمد مع الأخذ في الاعتبار الالتزام بالمعيار VDE 0100 الجزء 701 و IEC 60364 و IEC 60364-7-701 وكذلك 105-2-EN 60335.

⚠ يجب وضع كابل التيار الكهربائي في المقبس ويكون معزولاً عزلاً مزدوجاً.

## تعليمات التركيب

- قبل القيام بعملية التركيب، يجب فحص المنتج للتأكد من خلوه من أية تلفيات ناتجة عن النقل. بعد القيام بعملية التركيب، لن يتم الاعتراف بوجود أية تلفيات سطحية أو تلفيات ناتجة عن عملية النقل.
- يجب تركيب وغسيل واختبار التوصيلات وخلطات المياه طبقاً للمعايير السارية.
- يجب مراعاة القواعد الخاصة بالتركيب وأعمال السباكة وفقاً للوائح الخاصة بكل

## وصف الرمز

أنبوب أسلاك لكابلات التيار		توصيلة مياه DN20 ماء دافئ		هام! لا تستخدم السليكون الذي يحتوي على أحماض!	
سطح ساخن!		توصيلة مياه DN20 ماء بارد		أبعاد (راجع صفحة 32)	
يجب ارتداء قفازات الحماية		صمام التدفق		مثال على التركيب (راجع صفحة 34)	
يجب ارتداء تجهيزات حماية العين		تغيير مسار رباعي كواترو		التشغيل (راجع صفحة 31)	
إسفنجة طبيعية		صمام حجز وتغيير تريبو يونيفرسال		قطع الغيار (راجع صفحة 31)	
مزيل تكلس (بحامض الليمون)		ثرموستات HighFlow		الصيانة إستبدال وسيلة الإضاءة (راجع صفحة 52)	
يجب تجنب ملامسة المنتج للعين والجلد. وفي حالة ملامسة المنتج للعين يجب غسلها جيداً بالماء.		يجب أن تكون قدرة الصرف أكبر من 50 لتر/دقيقة		التنظيف (راجع صفحة 50) والكتيب المرفق	
تشغيل/ إيقاف الكهرباء		تصريف		مختص تركيب إلكترونيات	
شهادة اختبار (راجع صفحة 54)		بانايو مزود بدش في المنتصف		الصيانة (راجع صفحة 53)	
		افتح خلط الماء. / قم بإيقاف المياه		يجب إختبار وظائف تجهيزات الأمان طبقاً للوائح DIN EN 1717 وبشكل دوري وذلك بالتوافق مع القواعد المحلية والجهوية السائدة DIN 1988 وبشكل سنوي.	

التركيب المجموعة الرئيسية راجع صفحة 42

التركيب مجموعة كاملة. راجع صفحة 47



# Rainmaker

26115000 / 26117000 /  
28403000 / 28404000

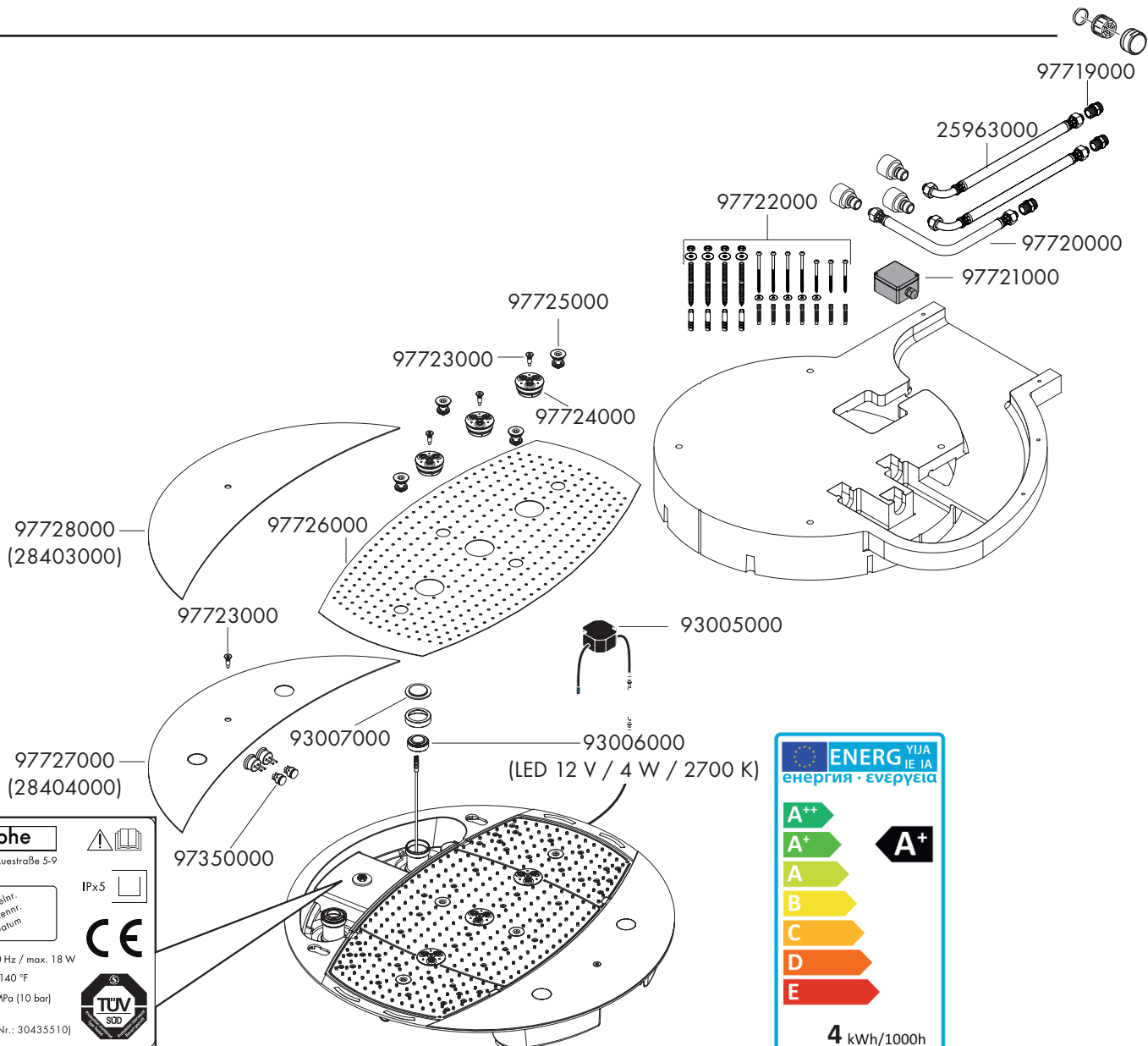
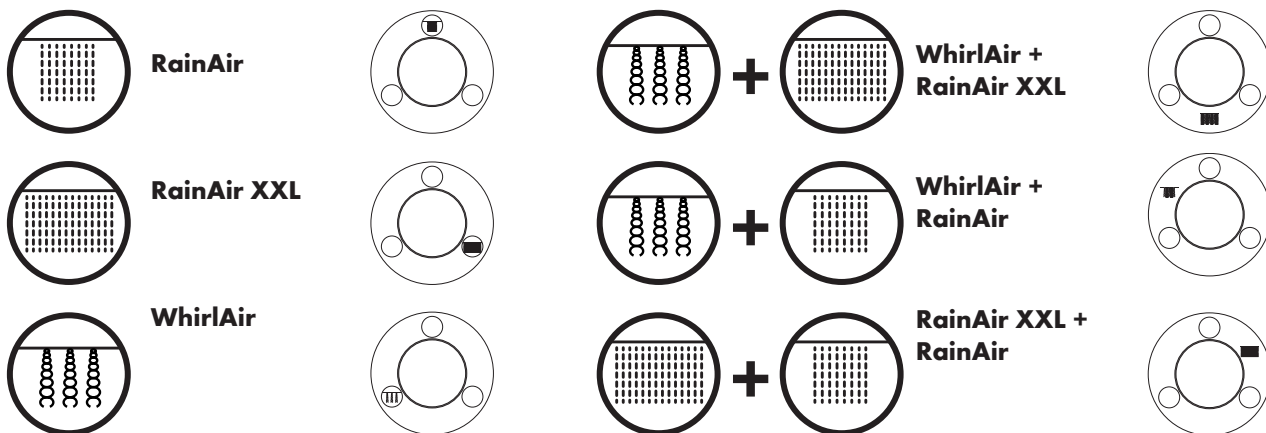
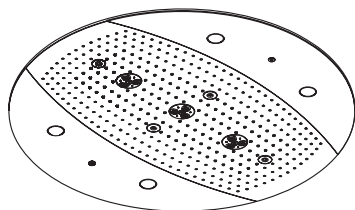

**hansgrohe**

D-77761 Schiltach, Austraße 5-9

Type: Rainmaker

Art.-No.

Ser.-No.

Artikelnr.

Serienr.

Datum

IPx5

CE

TUV SUD

100 - 240 V AC / 50 - 60 Hz / max. 18 W

max = 60 °C / 140 °F

max = 1 MPa (10 bar)

4 x 4 W (Produkt-Nr.: 30435510)

ENERGY LABEL

енергия · енергетика

A++

A+

A

B

C

D

E

**A+**

4 kWh/1000h

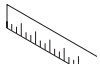

### Rainmaker

26117000 / 28404000 / 28412180

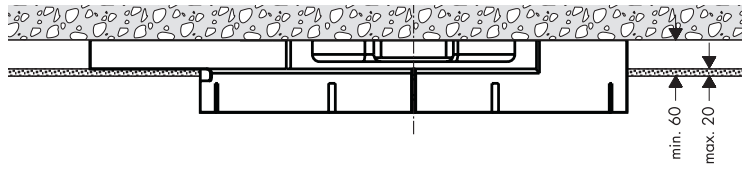
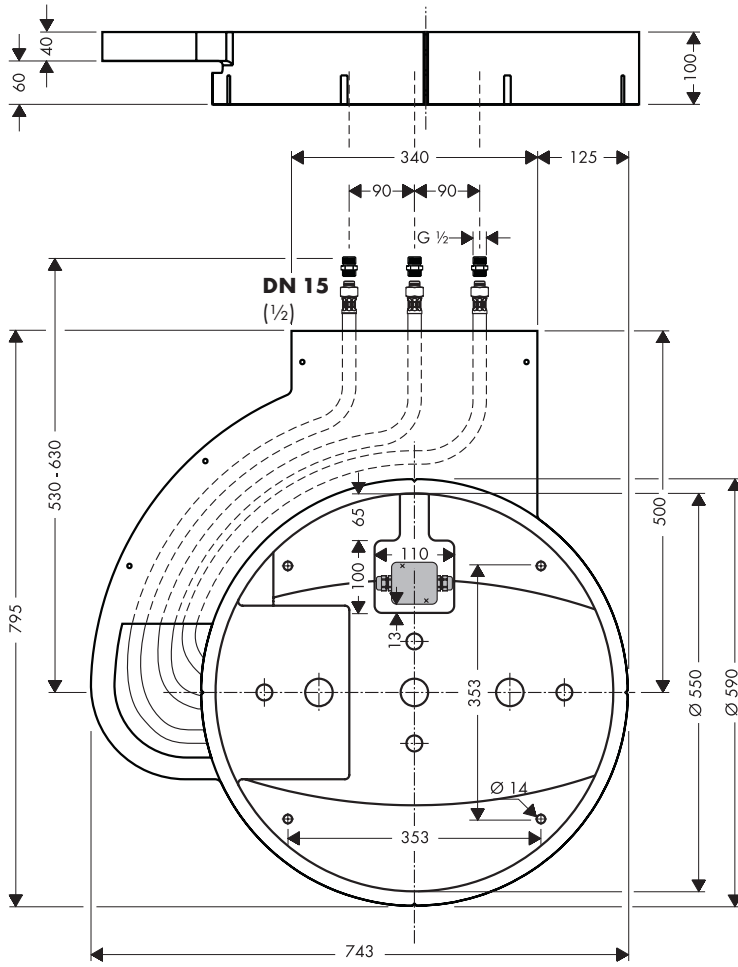

### Rainmaker

26115000 / 28403000 / 28412180

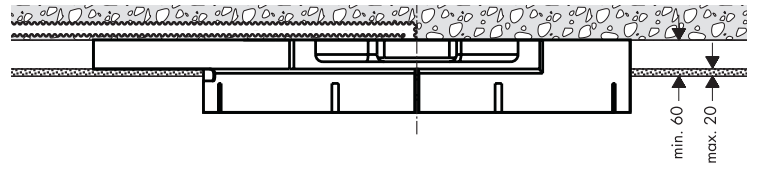
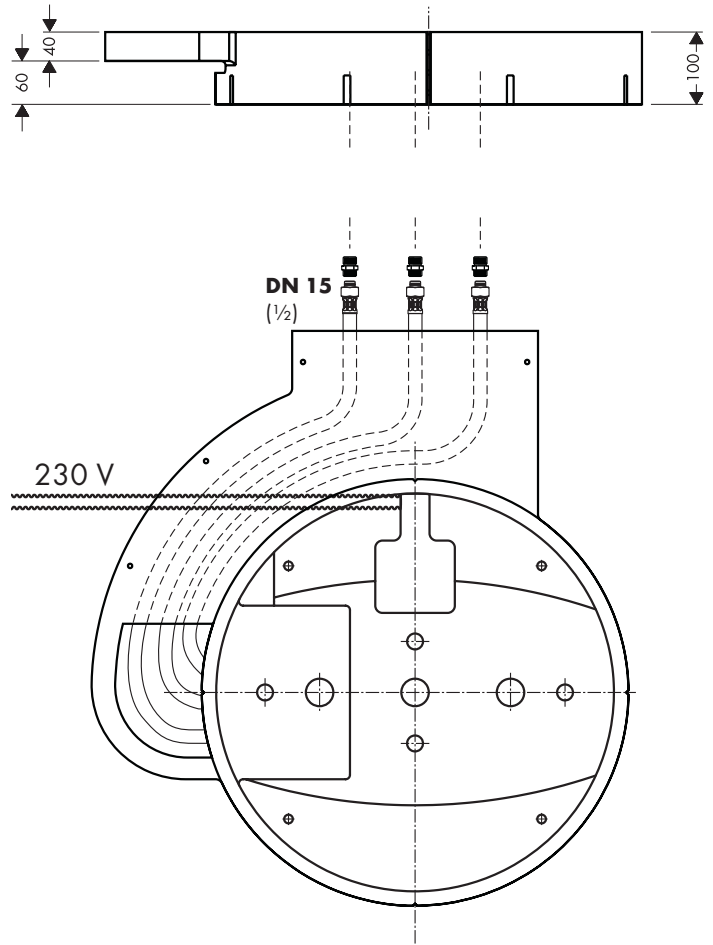





### Rainmaker

26115000 / 26117000 / 28403000 / 28404000

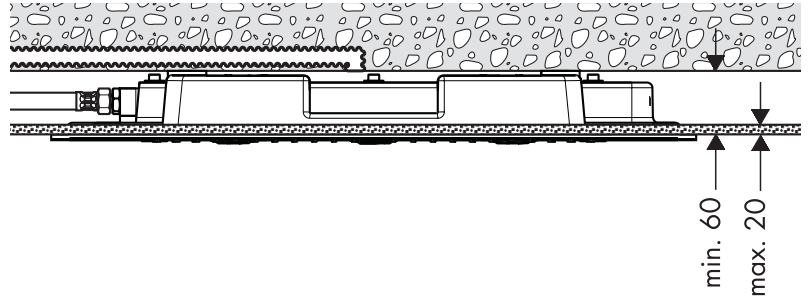
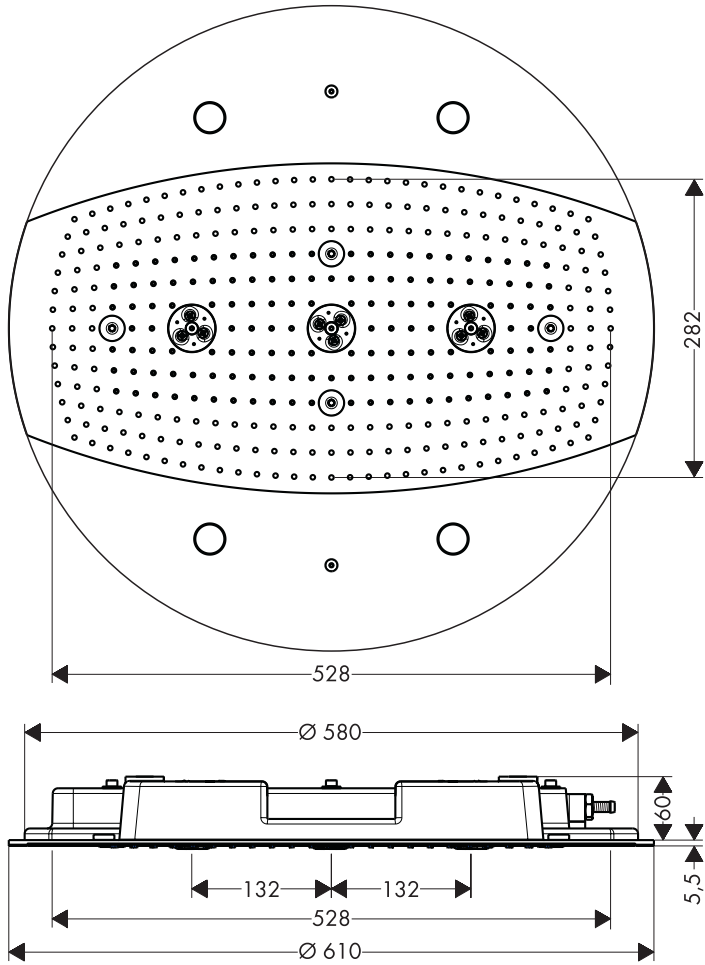

### Rainmaker

28403000  
28404000

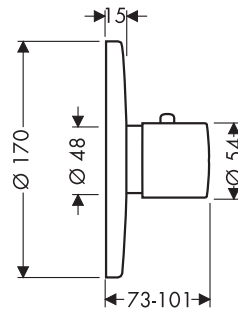



RainAir

RainAir XXL

WhirlAir

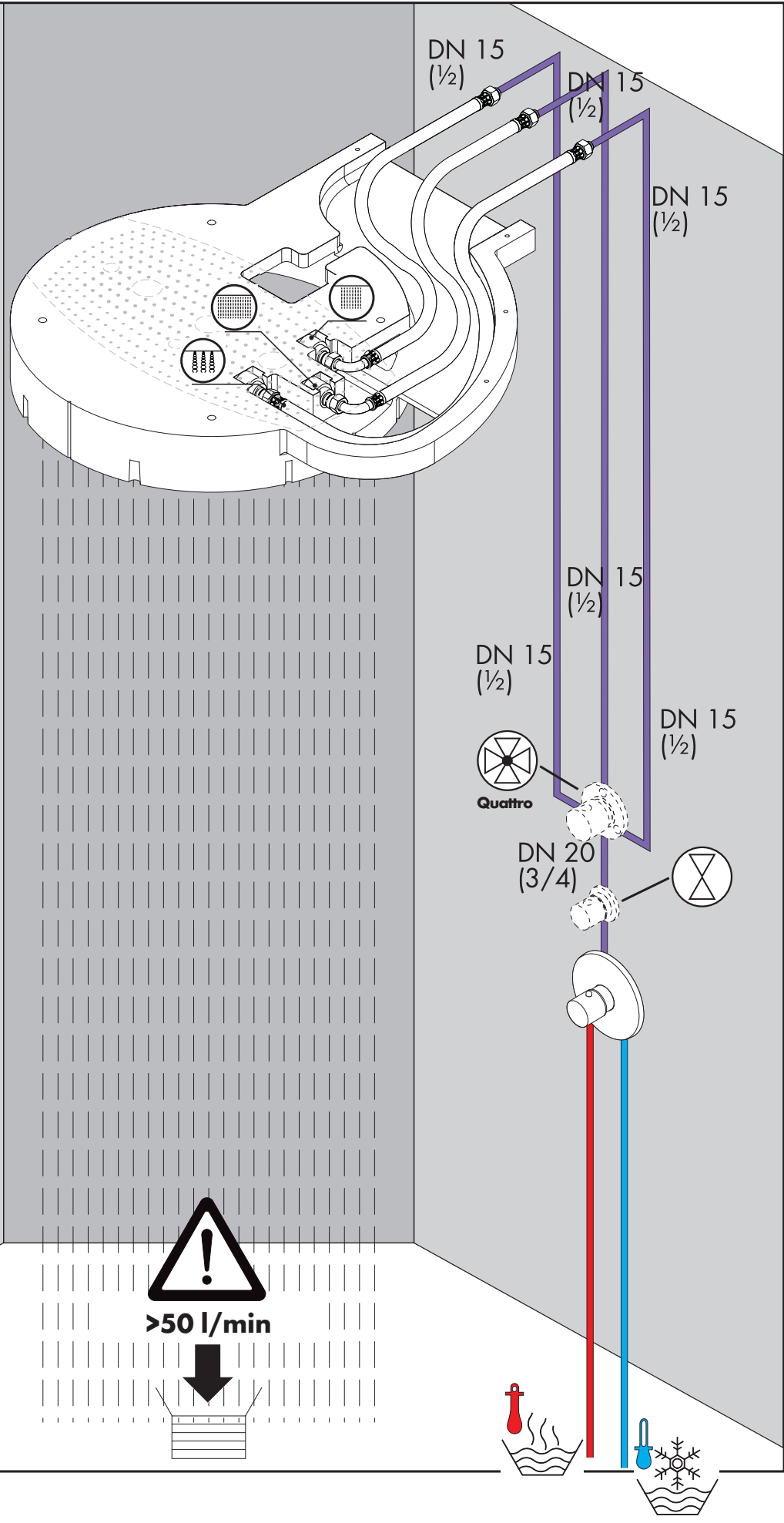

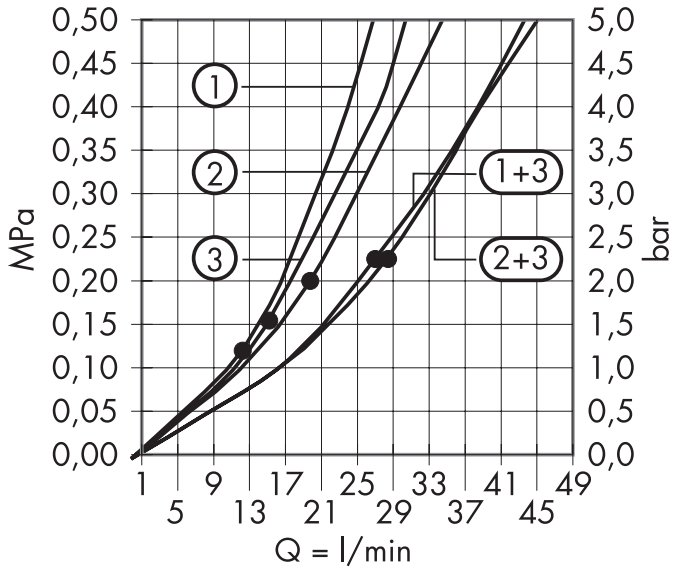

**Raindance Rainmaker**

- ① = RainAir
- ② = RainAir XXL
- ③ = WhirlAir
- ①+③ = RainAir + WhirlAir
- ②+③ = RainAir XXL + WhirlAir

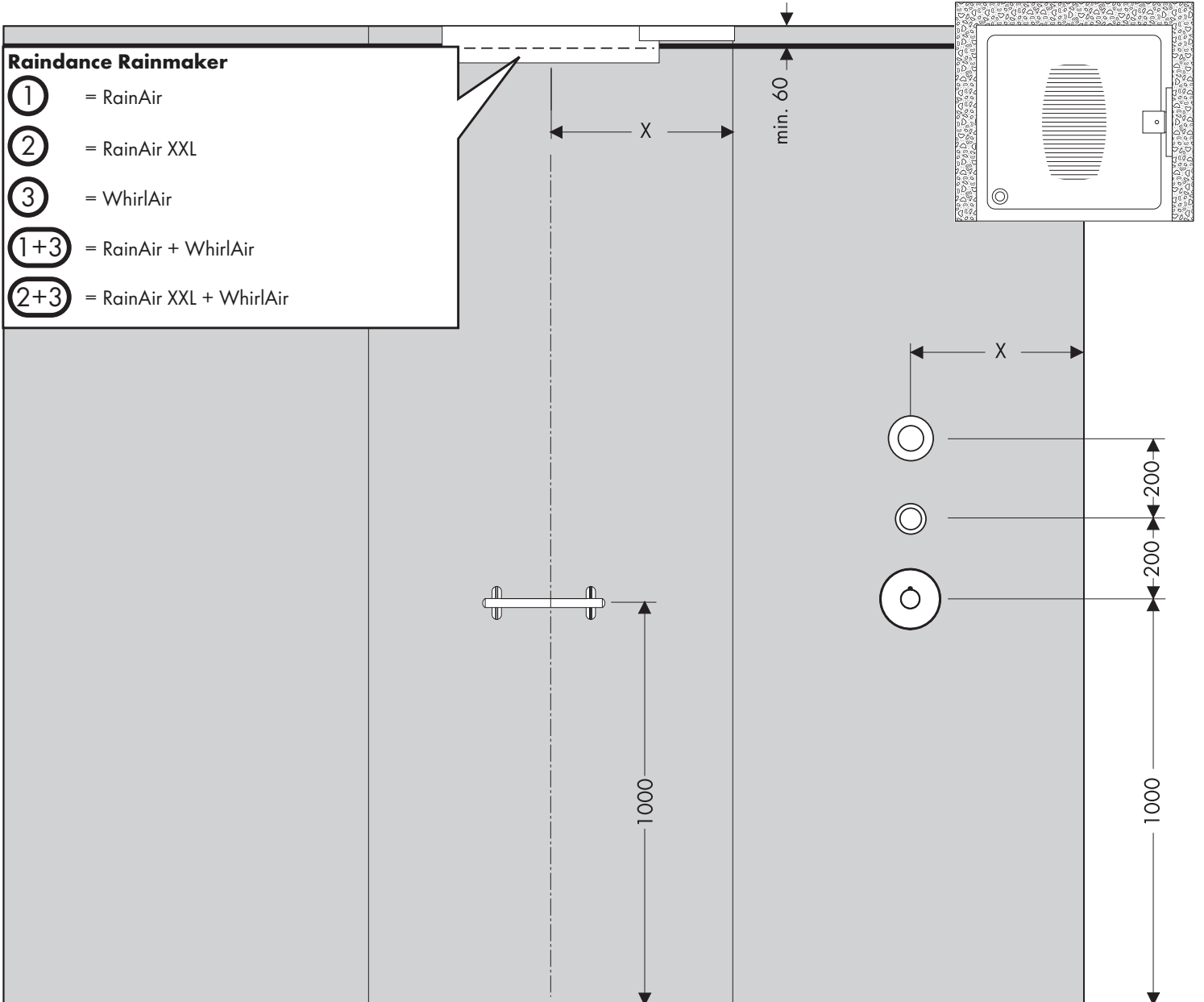



RainAir

RainAir XXL

WhirlAir

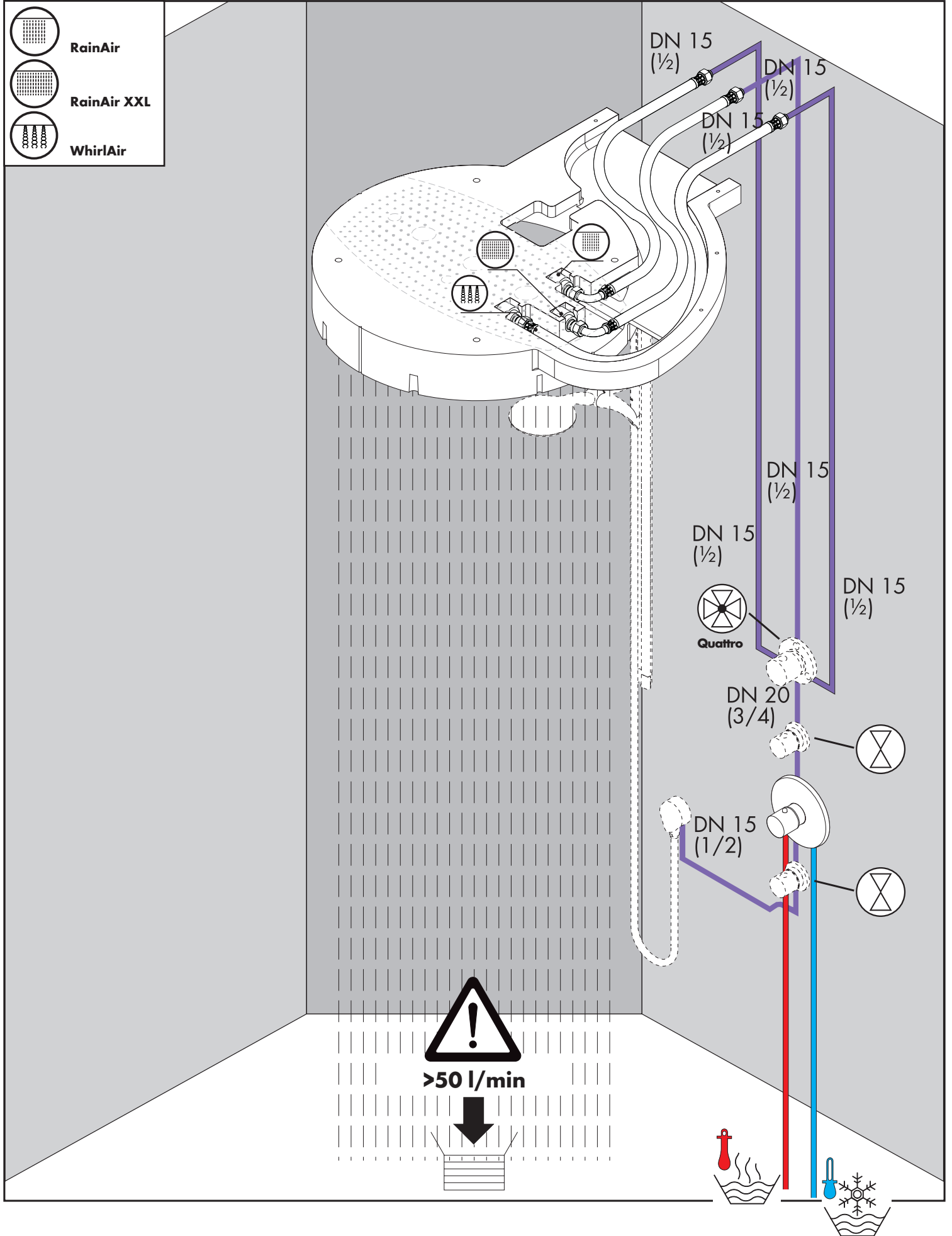

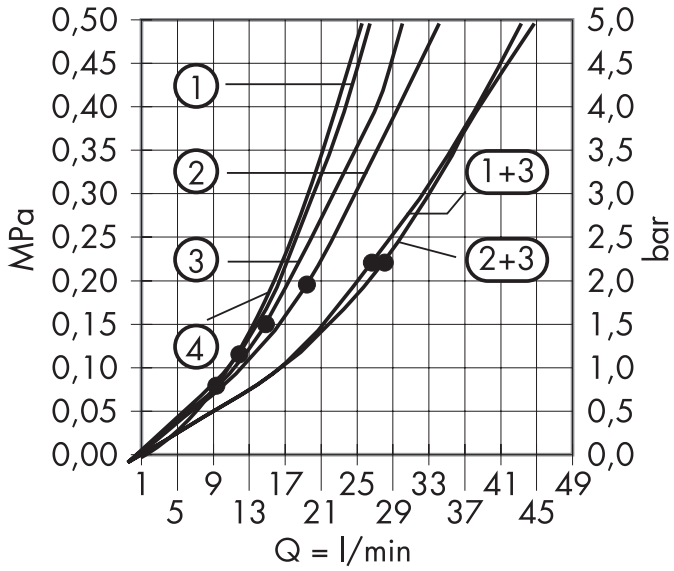

**Raindance Rainmaker**

- ①** = RainAir
- ②** = RainAir XXL
- ③** = WhirlAir
- ①+③** = RainAir + WhirlAir
- ②+③** = RainAir XXL + WhirlAir

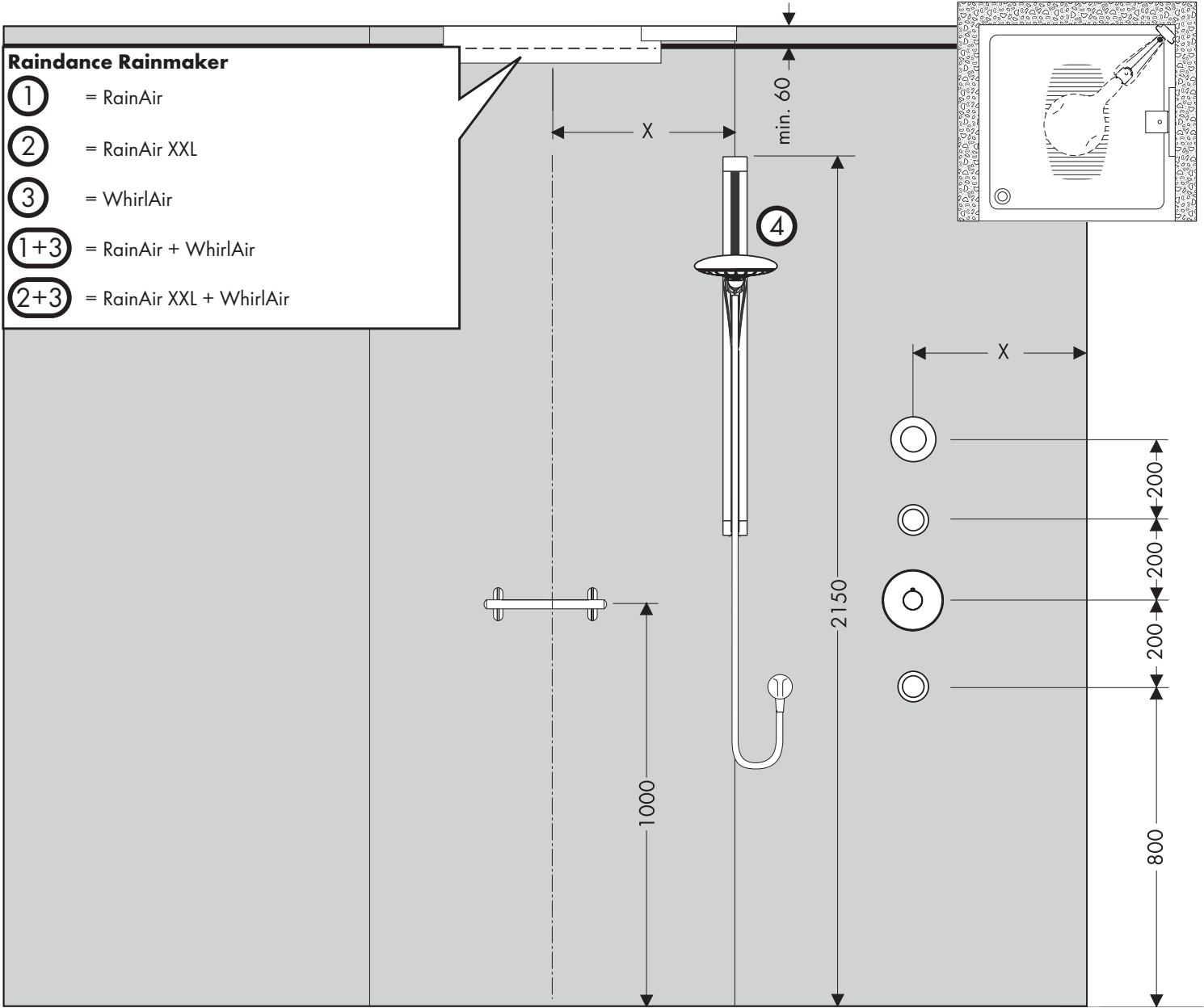



RainAir



RainAir XXL



WhirlAir

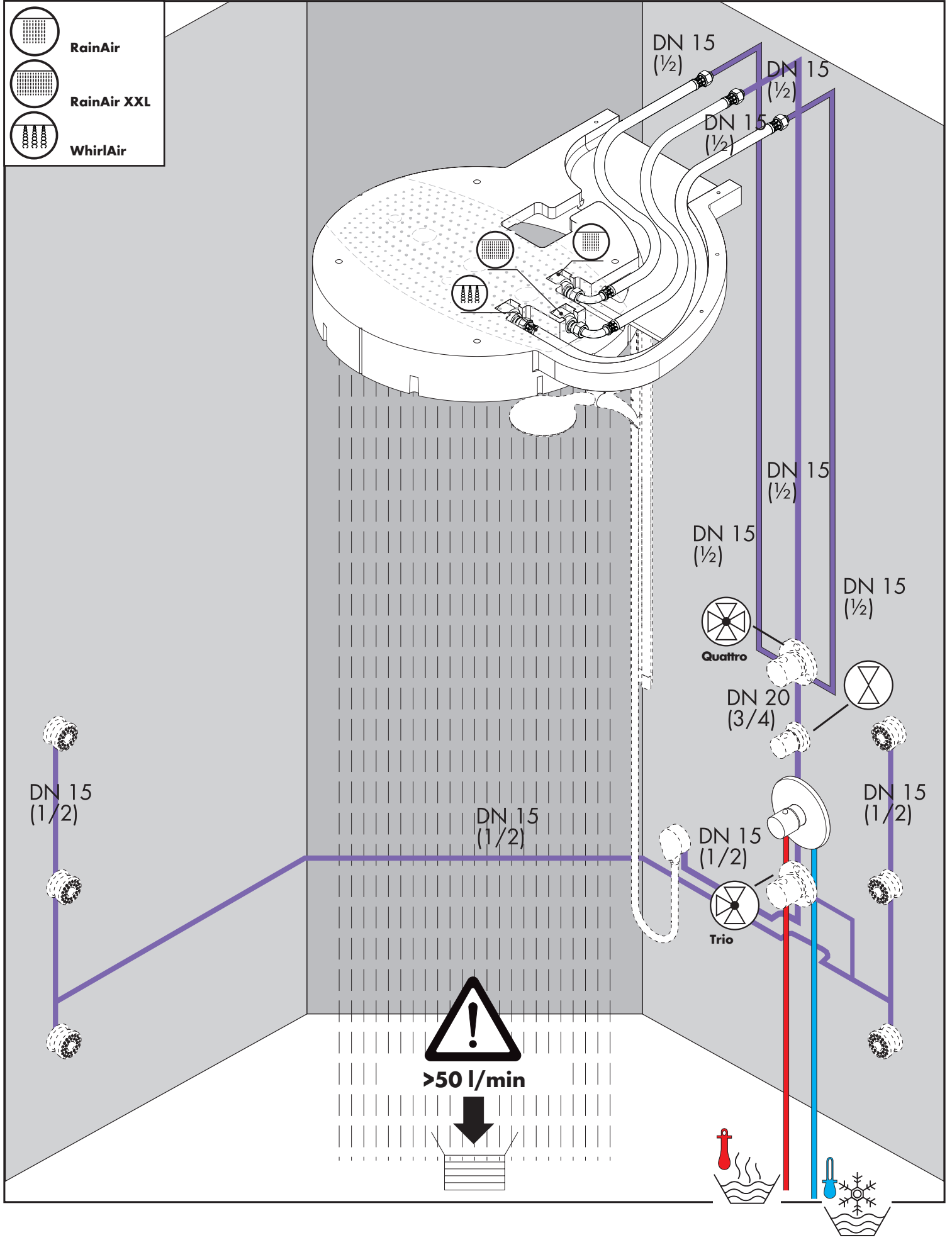

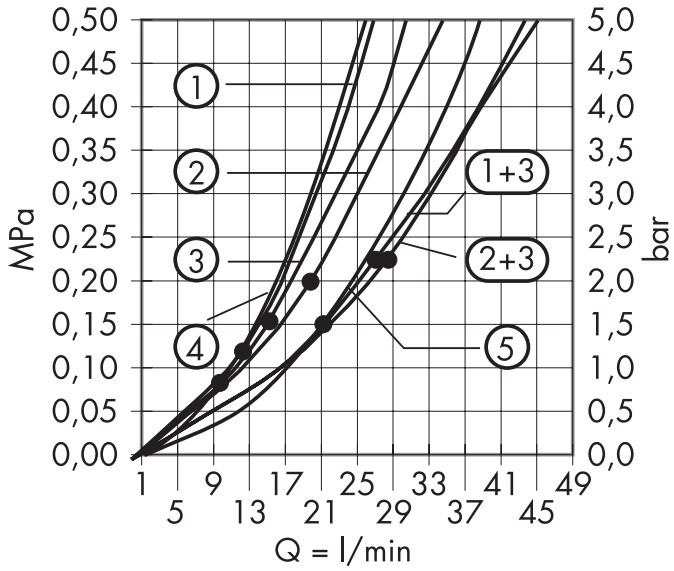

**Raindance Rainmaker**

- ① = RainAir
- ② = RainAir XXL
- ③ = WhirlAir
- ①+③ = RainAir + WhirlAir
- ②+③ = RainAir XXL + WhirlAir

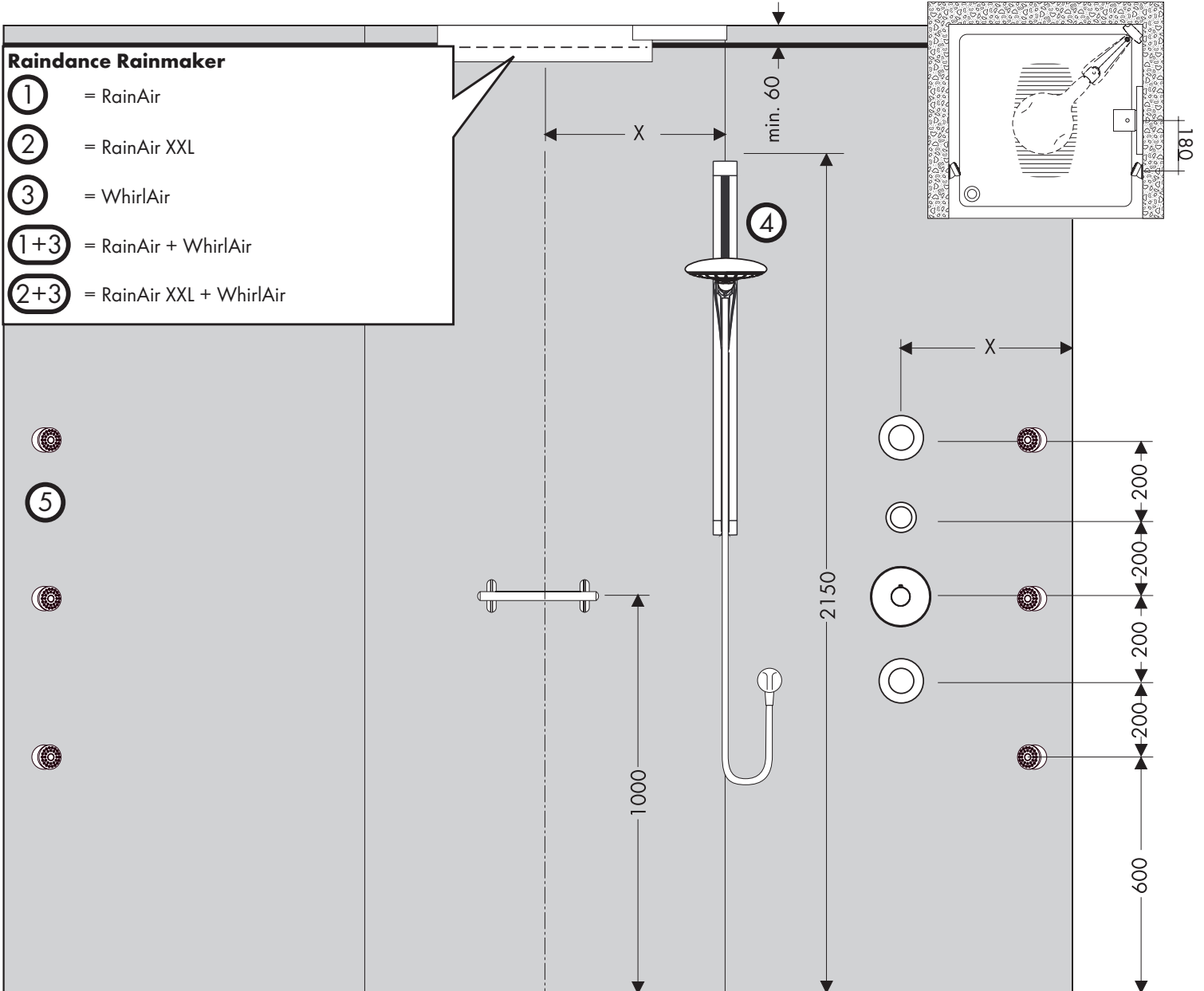

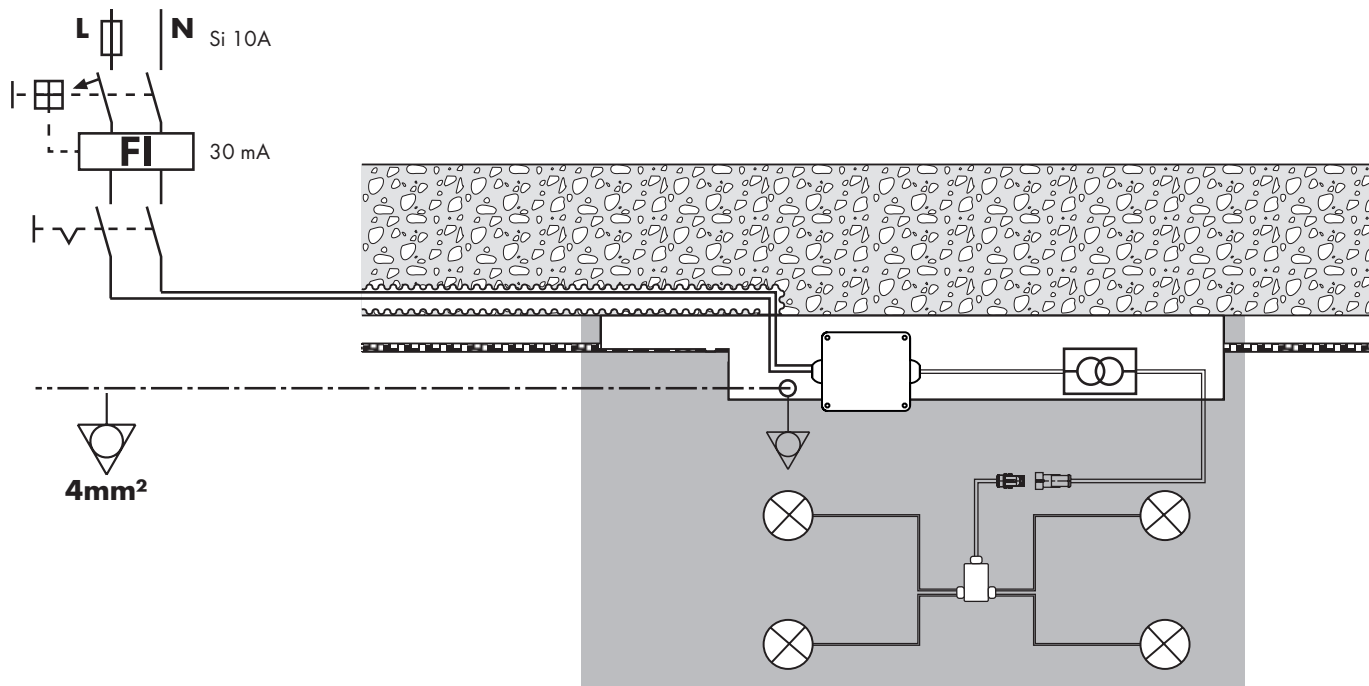

	PA /	N	L							
<b>DE</b>	Potentialausgleich (PA) 4 mm	Neutralleiter	Außenleiter	FI-Schutzschalter 30 mA	Lichtschalter	Anschlussdose	Netzteil 100 - 240V AC 18 W / 12V DC SELV	Leuchtmittel	Steckverbindungen	Verteilerbox
<b>FR</b>	Compensation de potentiel (PA) 4 mm	Neutre	Conducteur	Disjoncteur FI 30 mA	Interrupteur boîtier de raccordement	transformo 100 - 240V AC 18 W / 12V DC SELV	Moyen d'éclairage	Connecteur	Distributeur	
<b>EN</b>	Potential equalisation (PA) 4 mm	neutral conductor	conductor	FI protective switch 30 mA	light switch	junction box	transformer 100 - 240V AC 18 W / 12V DC SELV	illuminant	connectors	distributor box
<b>IT</b>	Compensazione di potenziale (PA) 4 mm	conduttore neutro	conduttore	interruttore di sicurezza per correnti di guasto 30 mA	interruttore luce	scatola di raccordo	trasformatore 100 - 240V AC 18 W / 12V DC SELV	Lampada	collegamenti a spina	cassetta distribuzione
<b>ES</b>	Protección equipotencial (PA) 4 mm	Conductor neutro	Conductor	Commutador de protección FI 30 mA	Interruptor de luz	Caja de conexión	Transformador 100 - 240V AC 18 W / 12V DC SELV	Luces	Uniones insertables	Caja de distribución
<b>NL</b>	Potentialvereffening (PA) 4 mm	Nulgeleider	Geleider	FI-veiligheidsschakelaar 30 mA	Lichtschakelaar	aansluiting	trafo 100 - 240V AC 18 W / 12V DC SELV	Verlichtingsmiddel	Steekverbinding	Verdeelbox
<b>DK</b>	Potentialudligning (PA) 4 mm	Nulleder	Leder	FI-beskyttelseskontakt 30 mA	lyskontakt	Tilslutningsdåse	Transformer 100 - 240V AC 18 W / 12V DC SELV	lyskilde	Stikforbindelser	Fordelingskasse
<b>PT</b>	Ligação equipotencial (PA) 4 mm	Condutor neutro	Condutor	Interruptor FI 30 mA	Interruptor de luz	Caixa de derivação	Transformador 100 - 240V AC 18 W / 12V DC SELV	Lâmpada	Tomadas de ligação	Caixa de distribuição
<b>PL</b>	Wyrównanie potencjału (PA) 4 mm	Przewód zerowy	Przewód	Wyłącznik różnicowoprądowy FI 30 mA	Wyłącznik oświetleniowy	Przyłącze	Transformator 100 - 240V AC 18 W / 12V DC SELV	Źródło światła	Połączenia wtykowe	Skrzynka połączeniowa
<b>CS</b>	Vyrovnaní potenciálů (PA) 4 mm	Nulový vodič	Vodič	Ochranný spínač FI 30 mA	Spínač světla	připojovací krabice	Transformátor 100 - 240V AC 18 W / 12V DC SELV	Osvětlovací prostředek	Konektorová spojení	Krabička rozdělovače
<b>SK</b>	Vyrovnanie potenciálov (PA) 4 mm	Nulový vodič	Vodič	FI ochranný spínač 30 mA	Svetelný spínač	pripájacia krabica	Transformátor 100 - 240V AC 18 W / 12V DC SELV	Osvetlovací prostriedok	Konektorové spojenia	Skrinka rozdeľovača
<b>ZH</b>	电位均衡 (PA) 4 mm	零线	导线	FI保护开关 30 mA	照明开关	接线盒	变压器 100 - 240V AC 18 W / 12V DC SELV	灯具	插座连接	分线盒
<b>RU</b>	Выравнивание потенциалов (PA) 4 mm	Нулевой провод	Провод	Защитное реле FI 30 mA	Выключатель освещения	точка подключения	трансформатор 100 - 240V AC 18 W / 12V DC SELV	Осветительное средство	Штекерные соединения	Распределительная коробка
<b>HU</b>	Potenciálkiegyenlítés (PA) 4 mm	Nullvezeték	Vezeték	FI-védőkapcsoló 30 mA	Világításkapcsoló	Csatlakozó doboz	Trafó 100 - 240V AC 18 W / 12V DC SELV	Világítás	Dugaszoló csatlakozások	Elosztó doboz
<b>FI</b>	Potentialitasaus (PA) 4 mm	Nollajohdin	Johdin	FI-suojakytkin 30 mA	Valokytkin	Liitäntärasia	Muuntaja 100 - 240V AC 18 W / 12V DC SELV	Valonlähde	Pistokeliitäntä	Jakorasia



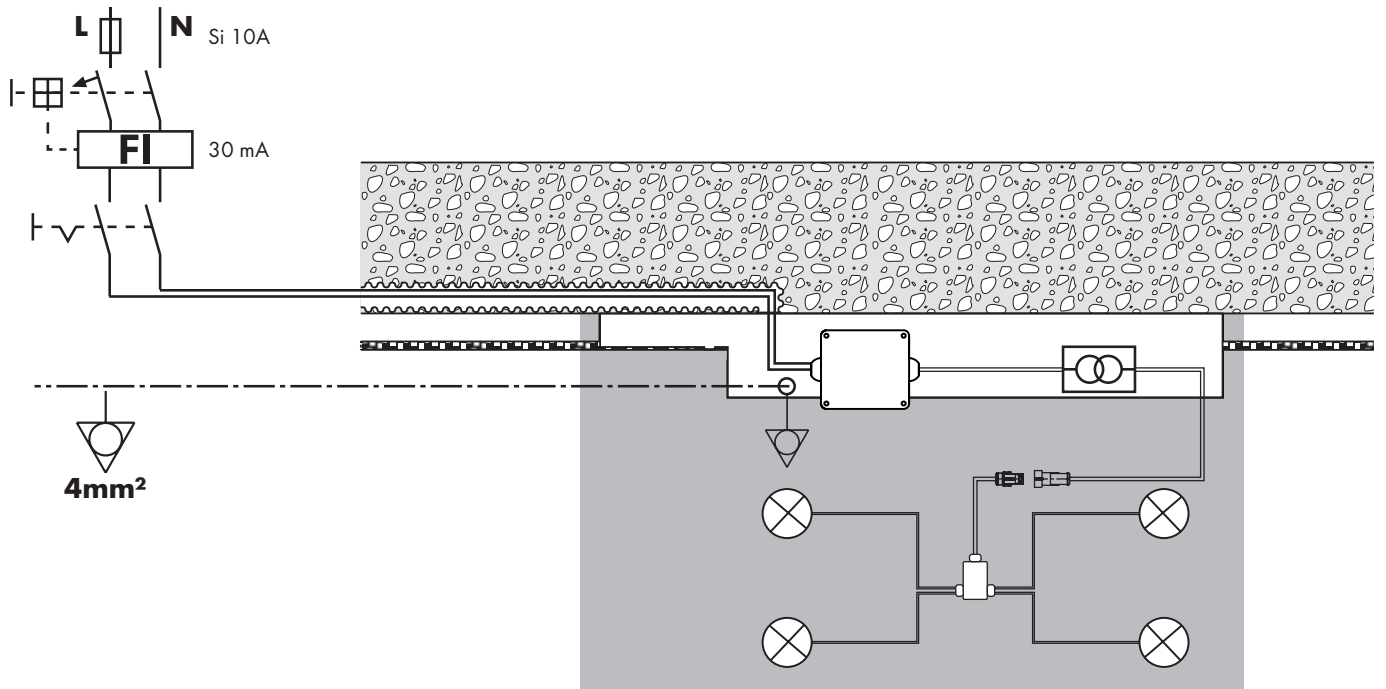

	PA /	N	L							
<b>SV</b>	Potentialutjämning (PA) 4 mm	Neutralledare	Ledare	Jordfelsbrytare 30 mA	Strömbrytare	Anslutningsdosa	Transformator 100 - 240V AC 18 W / 12V DC SELV	Glödlampa	Stickanslutning	Fördelare
<b>LT</b>	Potencialu išlyginimas (PA) 4 mm	nulinis laidas	laidas	FI apsauginis jungiklis 30 mA	elektros jungiklis	Prijungimo dėžutė	Transformatorius 100 - 240V AC 18 W / 12V DC SELV	Šviesos šaltinis	kištukinės jungtys	skirstomoji dėžutė
<b>HR</b>	Izjednačenje potencijala (PA) 4 mm	Nulti vodič	Vodič	FI-sklopka 30 mA	Prekidač za svjetlo	utičnica	transformator 100 - 240V AC 18 W / 12V DC SELV	Rasvjetno tijelo	Utični spojevi	Razdjelna kutija
<b>TR</b>	Potansiyel dengelemesi (PA) 4 mm	Sifir iletken	İletken	FI koruma şalteri 30 mA	Işık şalteri	Bağlantı kutusu	Trafo 100 - 240V AC 18 W / 12V DC SELV	Ampul	Soket bağlantıları	Dağıtıcı kutu
<b>RO</b>	Egalizare de potențial (PA) 4 mm	Fir neutru	Conductor	Înterupător de protecție FI 30 mA	Înterupător de lumină	Cutie de racord	Transformator 100 - 240V AC 18 W / 12V DC SELV	Lumină	Conexiuni	Cutie de distribuție
<b>EL</b>	Εξισωση δυναμικού (PA) 4 mm	Ουδέτερος Αγωγός	Διακόπτης προστασίας FI 30 mA	Διακόπτης φωτισμού	Κουτί σύνδεσης	Trafo (μετασχηματιστής) 100 - 240V AC 18 W / 12V DC SELV	Φωτιστικό	Ηλεκτρικοί συνδέτηρες	Κουτί διανομής	
<b>SL</b>	Potencialna izenačitev (PA) 4 mm	Ničelni vodnik	Vodnik	Zaščitno tokovno stikalo 30 mA	Stikalo za luč	Priključnica	Trafo 100 - 240V AC 18 W / 12V DC SELV	Svetilo	Vtične povezave	Razdelilna doza
<b>ET</b>	Potentsiaali tasakaalustamine (PA) 4 mm	neutraaljuhe	juhe	kaitse 30 mA	valguslüli	harukarp	transformaator 100 - 240V AC 18 W / 12V DC SELV	Valgusti	pistikühendused	harukarp
<b>LV</b>	Potenciāla izlīdzināšana (PA) 4 mm	nulles vads	vads	drošinātājs 30 mA	gaismas slēdzis	Pieslēguma rozete	Transformators 100 - 240V AC 18 W / 12V DC SELV	Apgaismes ķermenis	spraudkontakti	sadales kārba
<b>SR</b>	Izjednačenje potencijala (PA) 4 mm	Nulti provodnik	Provodnik	FI-sklopka 30 mA	Prekidač za svetlo	utičnica	transformator 100 - 240V AC 18 W / 12V DC SELV	Svetiljka	Utični spojevi	Razvodna kutija
<b>NO</b>	Potentialutjevning (PA) 4 mm	Nullleder	Leder	FI-vernebryter 30 mA	Lysbryter	Koblingskontakt	Transformator 100 - 240V AC 18 W / 12V DC SELV	Lysmiddel	Pluggforbindelse	Fordelerboks
<b>BG</b>	Изравняване на потенциала (PA) 4 mm	Нулев проводник	Проводник	Зашитен прекъсвач погрешен ток 30 mA	Прекъсвач за осветлението	Присъединителна кутия	Трансформатор 100 - 240V AC 18 W / 12V DC SELV	Осветително тяло	Щепселни съединения	Разпределителна кутия
<b>SQ</b>	Barazimi i potencialeve (PA) 4 mm	Lidhja neutrale	Lidhje	Çelësi mbrojtës FI 30 mA	Çelësi i dritës	Kutia lidhëse	Trafo 100 - 240V AC 18 W / 12V DC SELV	Ndriçuesi	Lidhjet e prizave	Kutia shpërndarëse

	PA /	N	L							
<b>AR</b>	معادلة الجهد الكهربائي (PA) 4mm	الموصل المحايد	موصل	مفتاح حماية FI 30 mA	مفتاح إضاءة	نقطة التوصيل	محول 100 - 240V AC 18W / 12V DC SELV	مادة إضاءة	توصيلات قابسية	صندوق توزيع

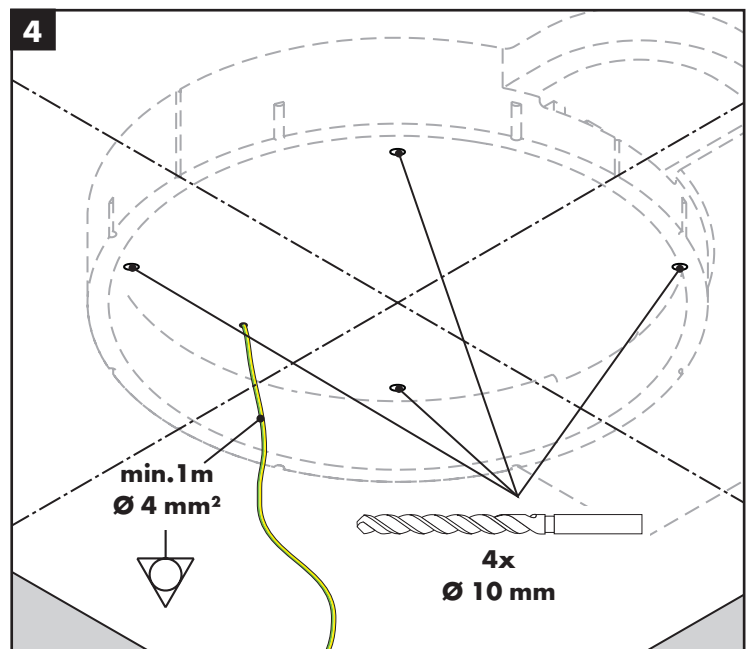
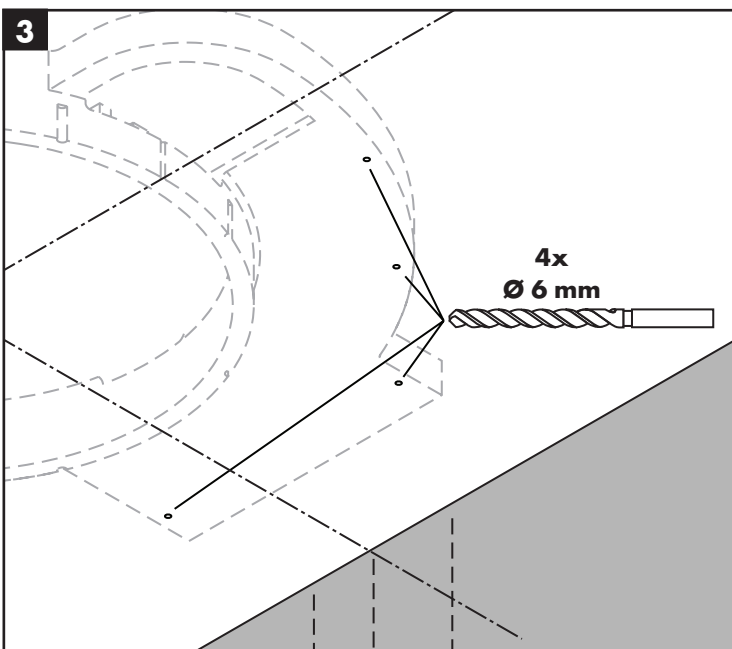
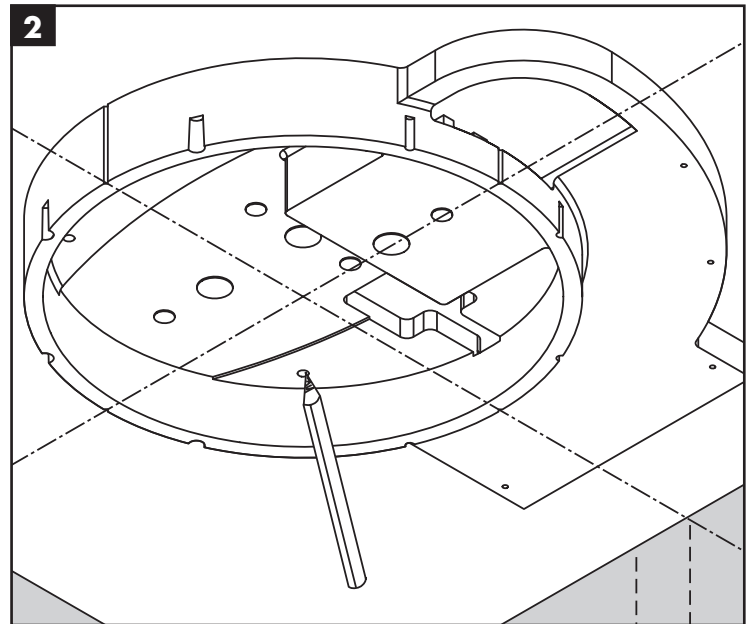
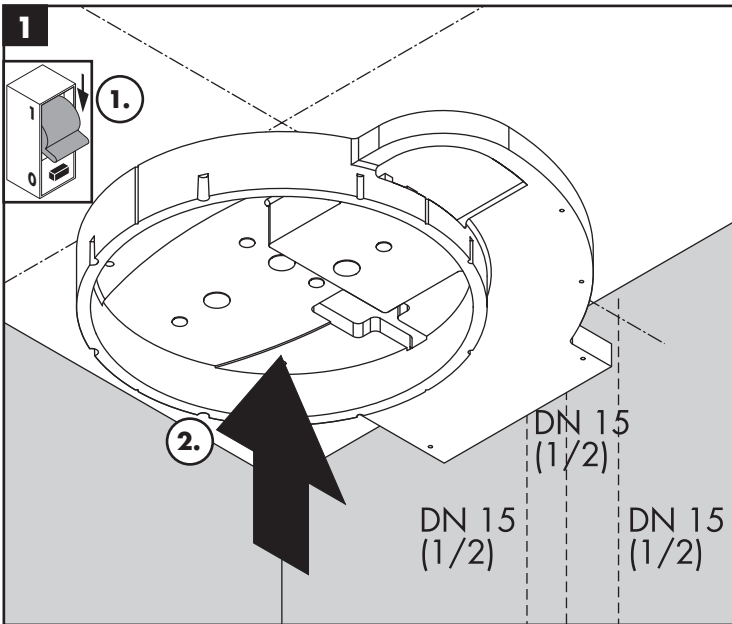
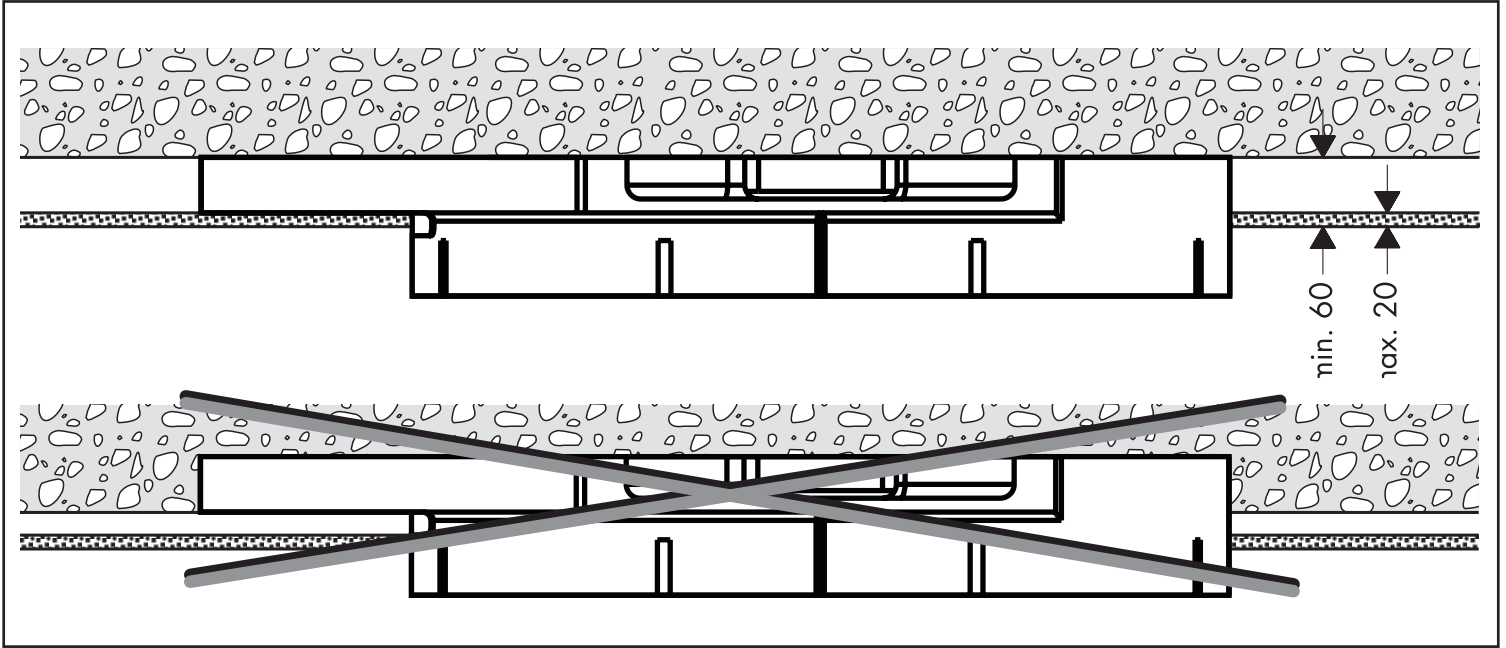

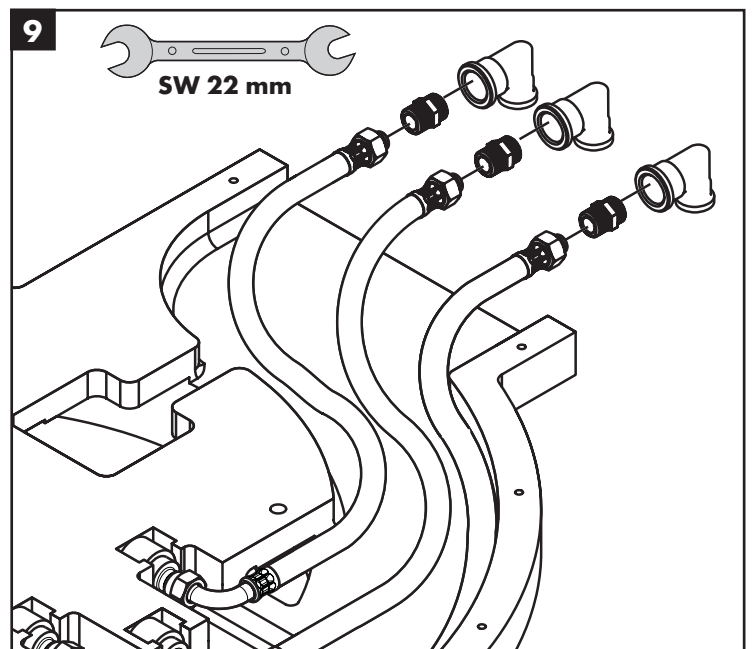
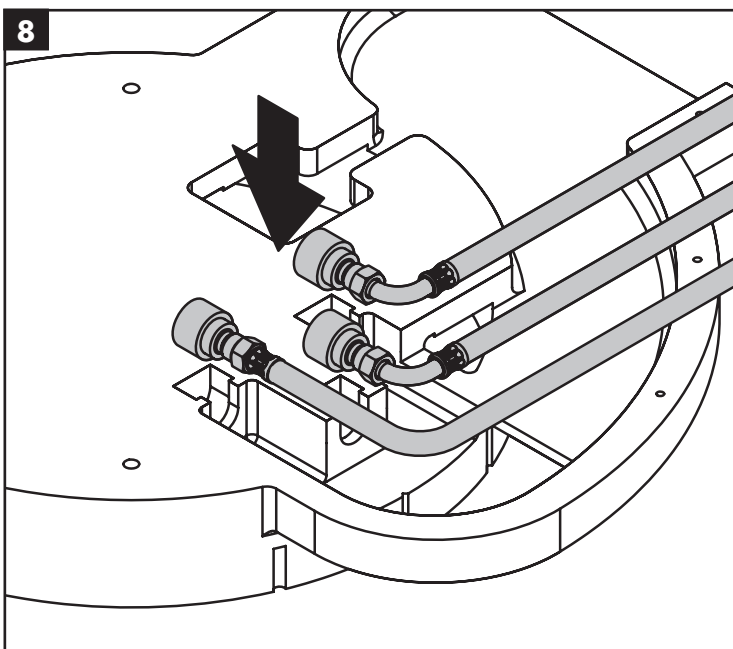
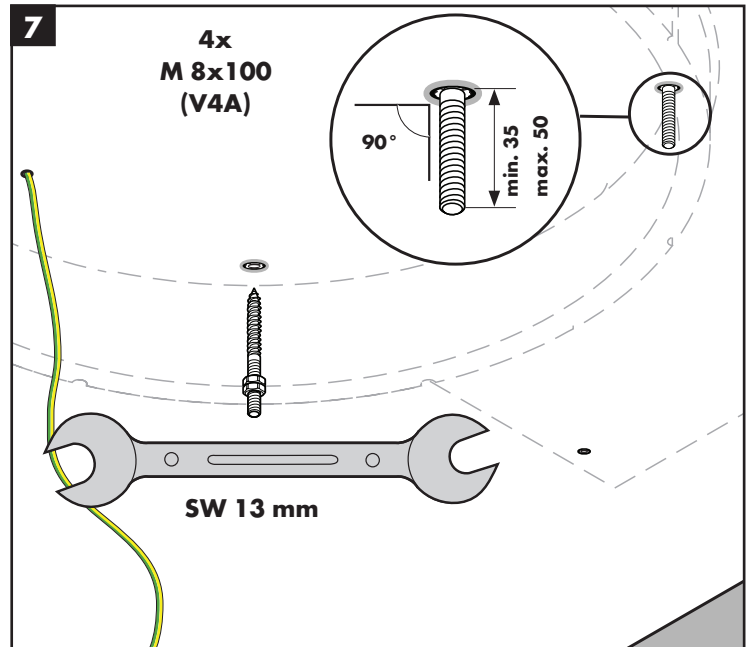
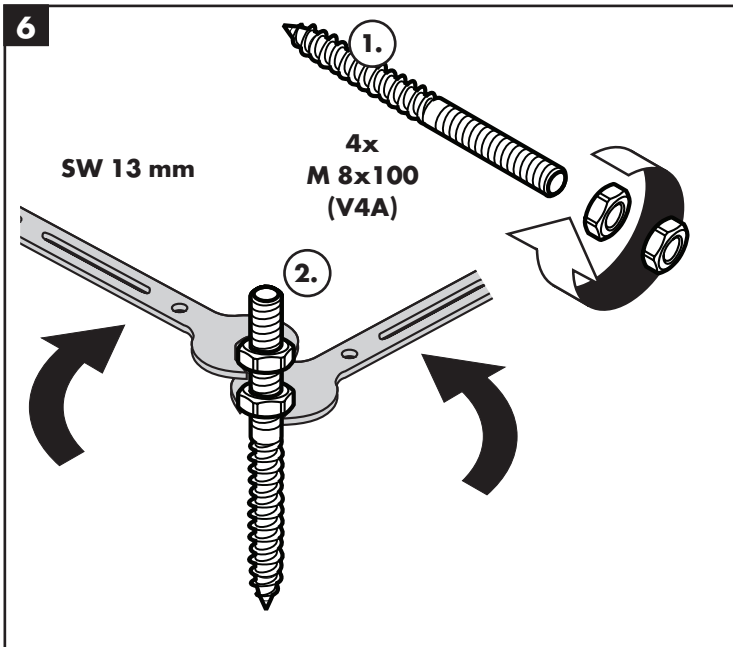
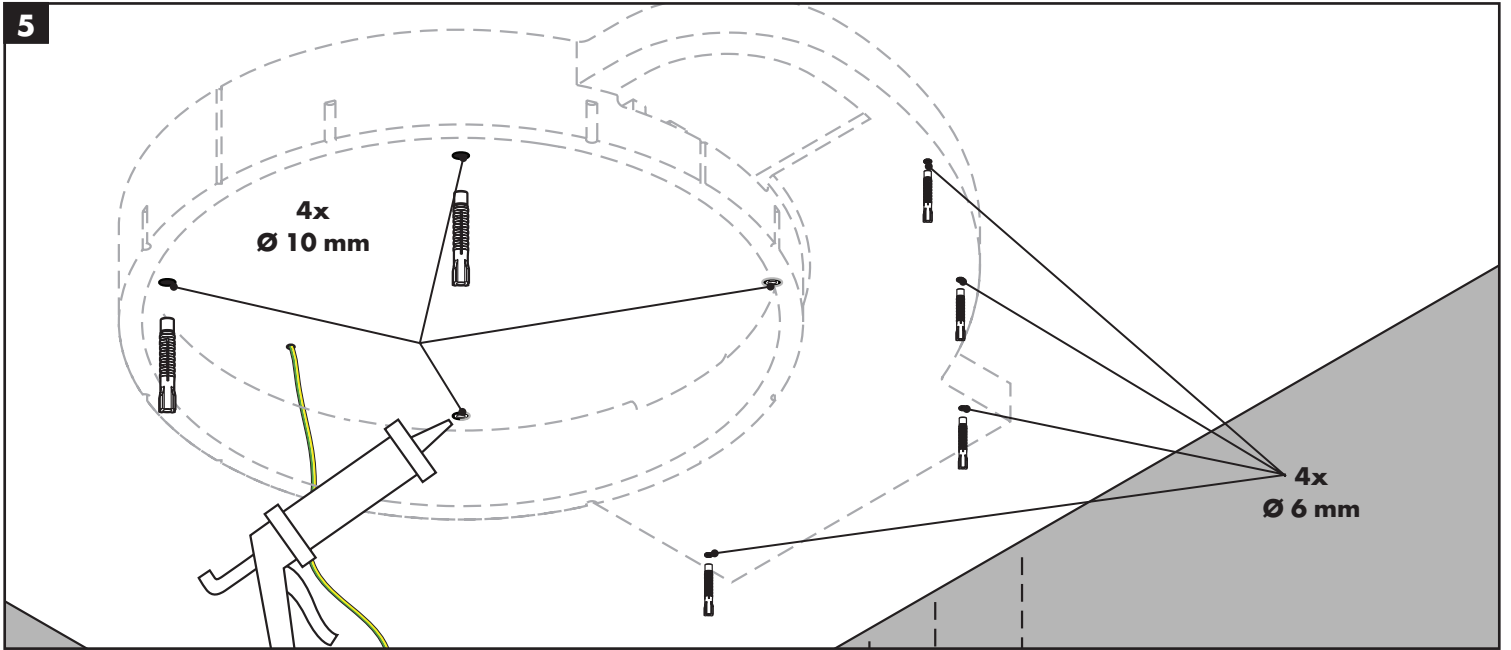

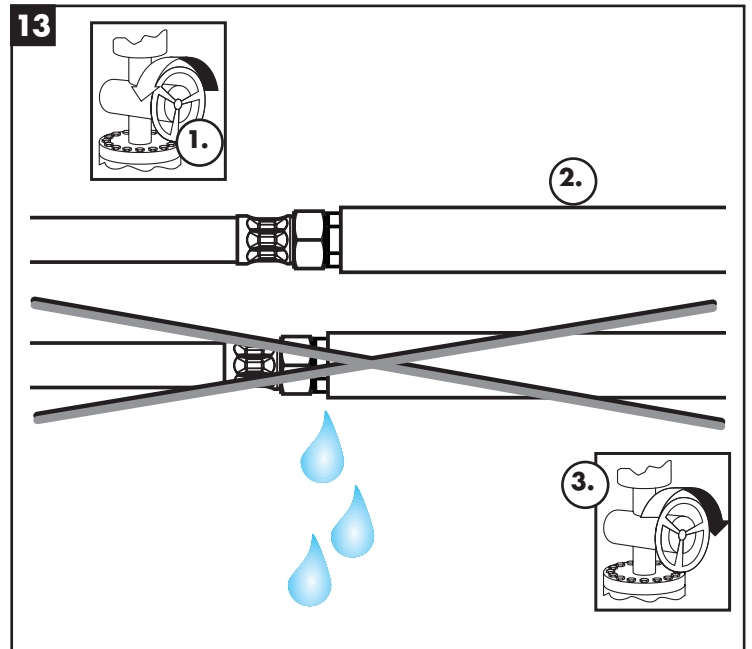
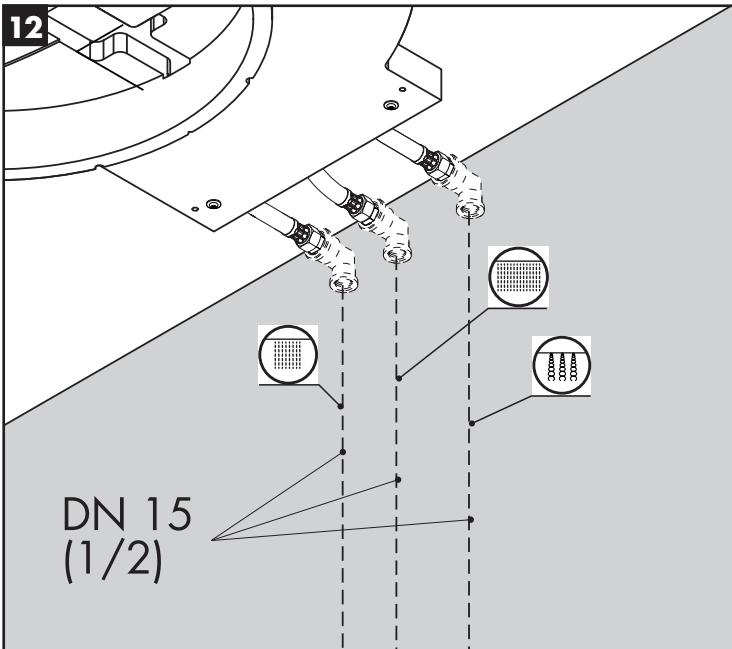
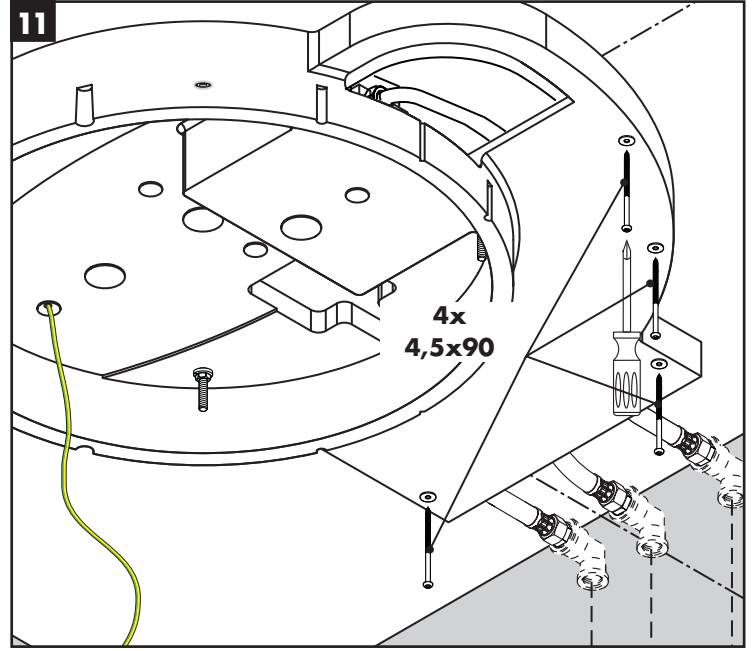
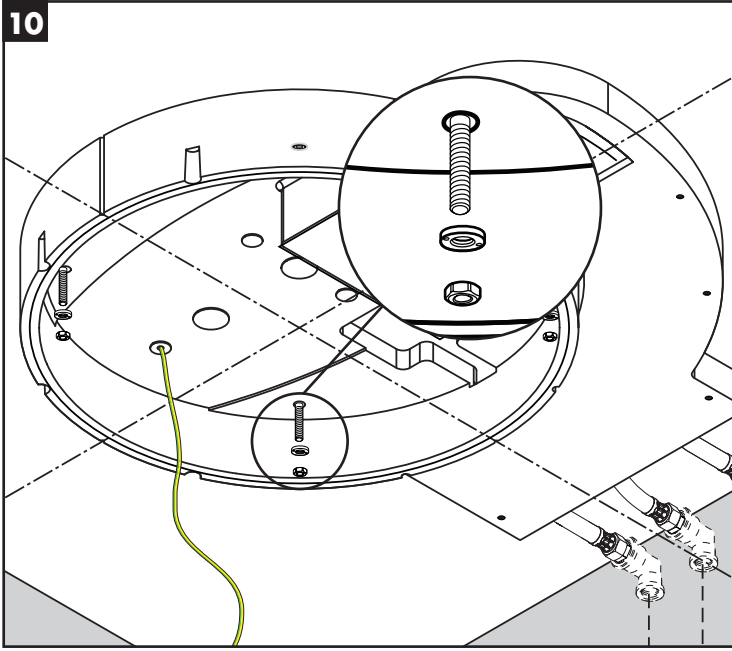

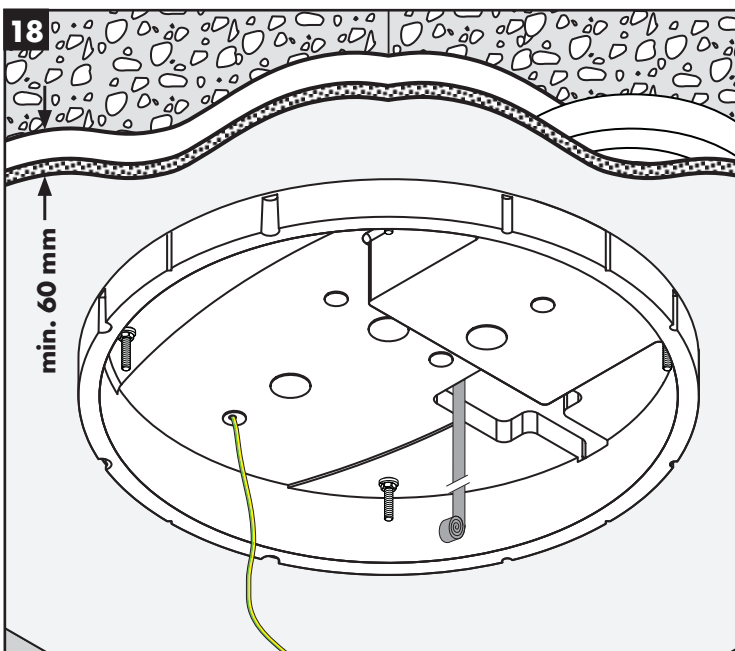
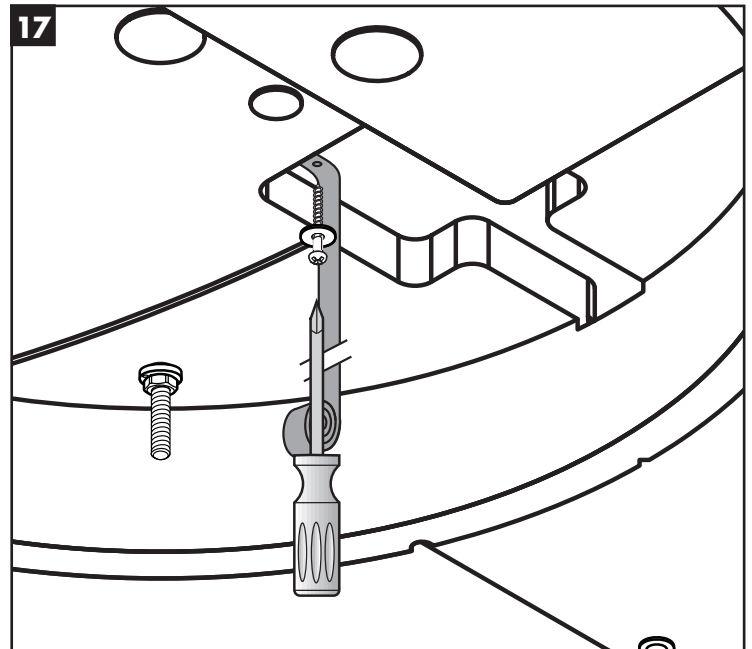
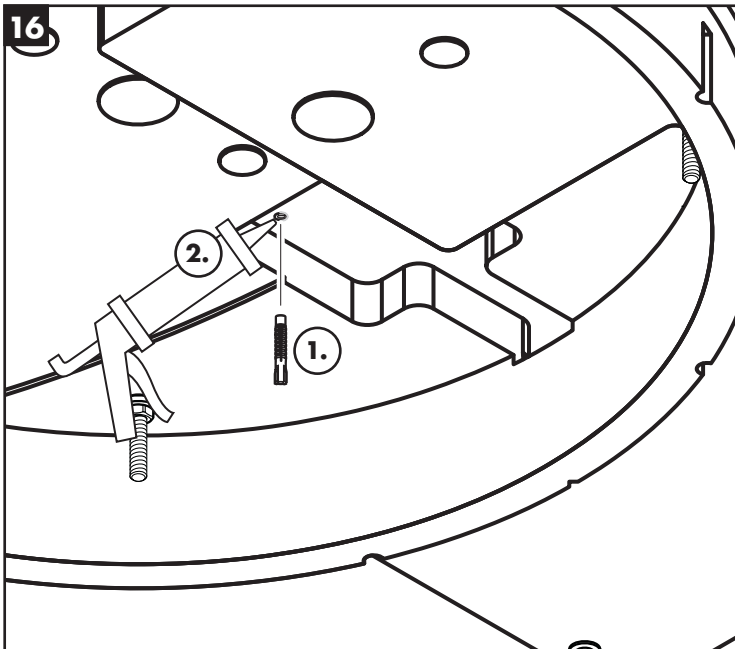
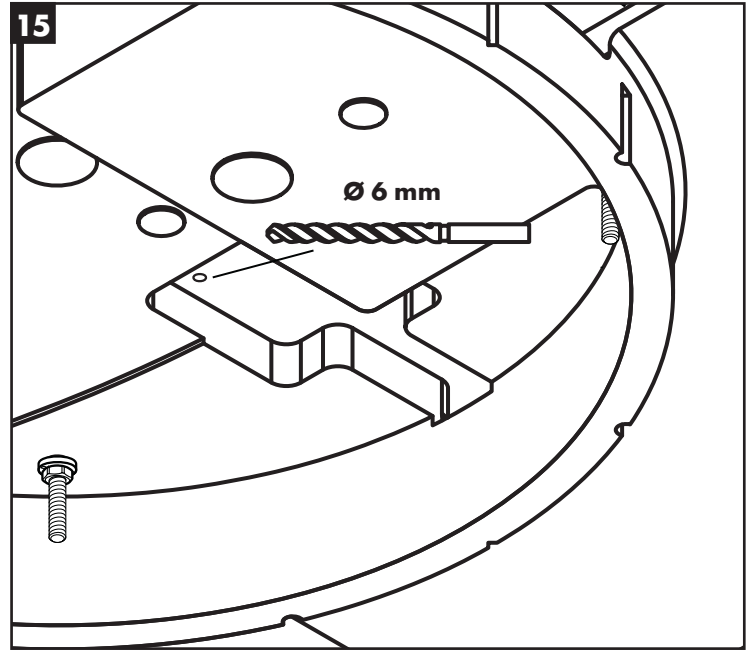
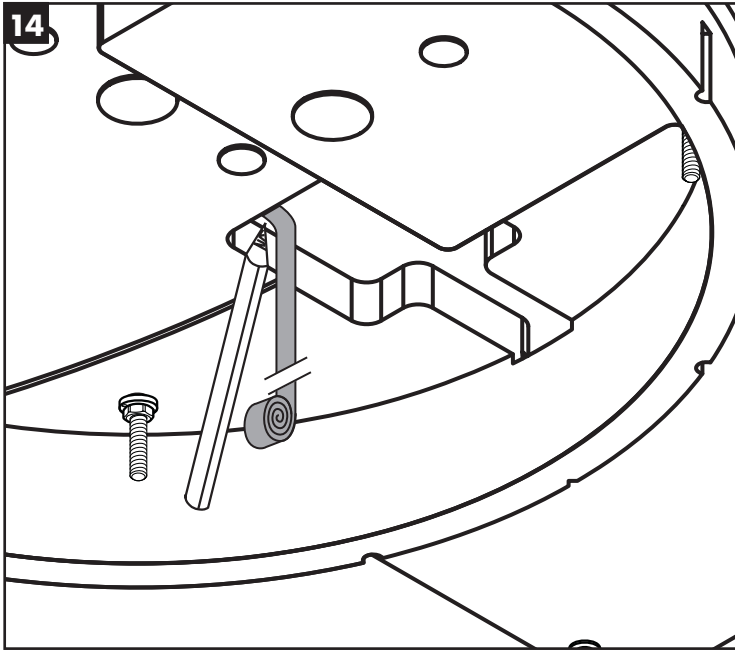

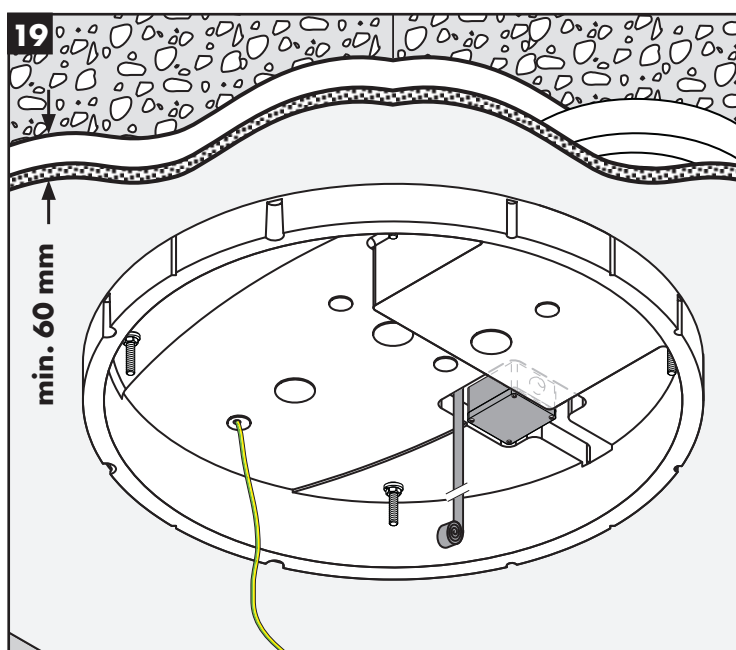
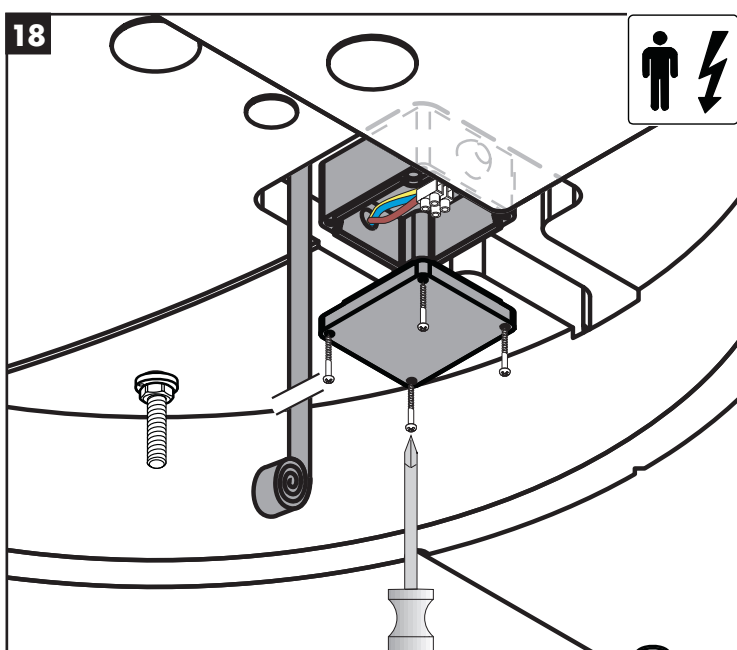
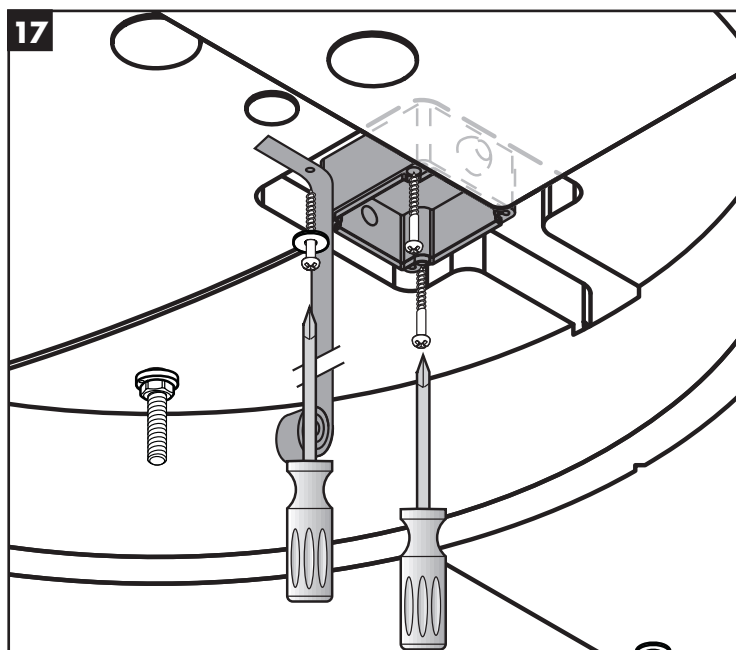
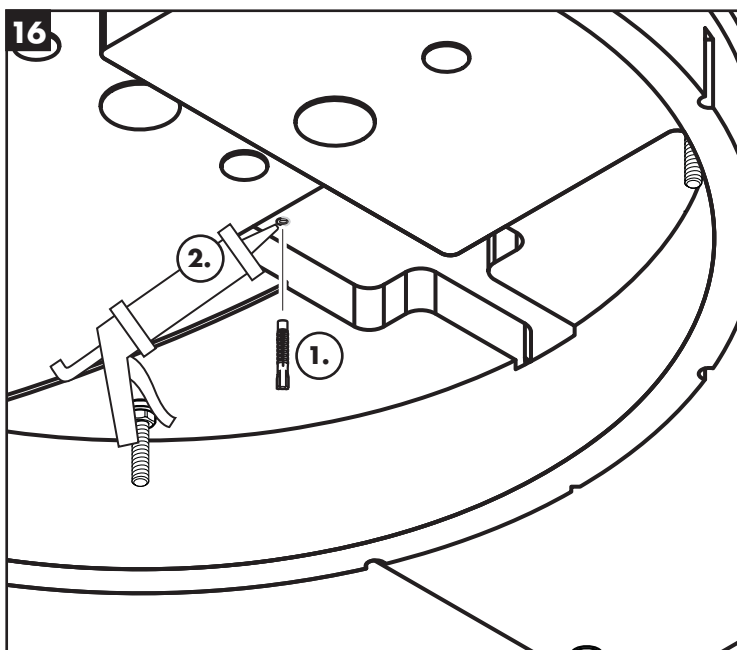
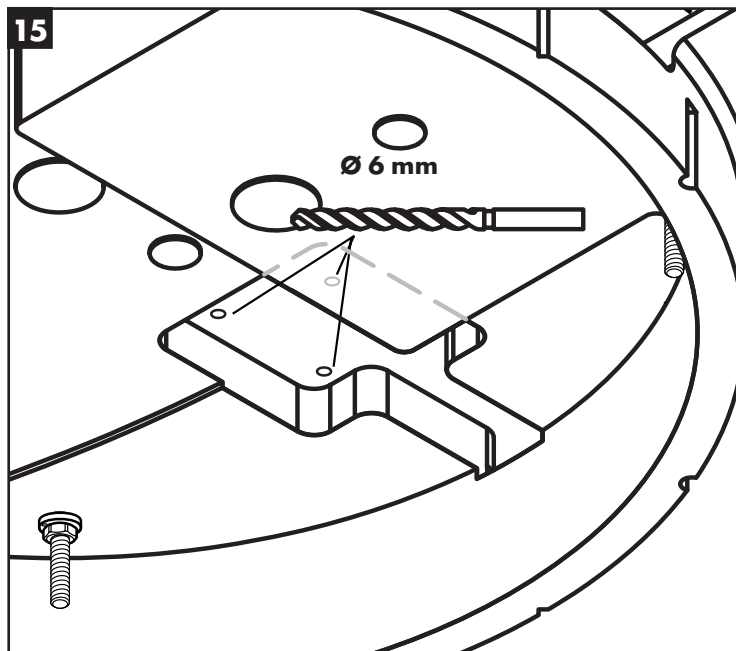
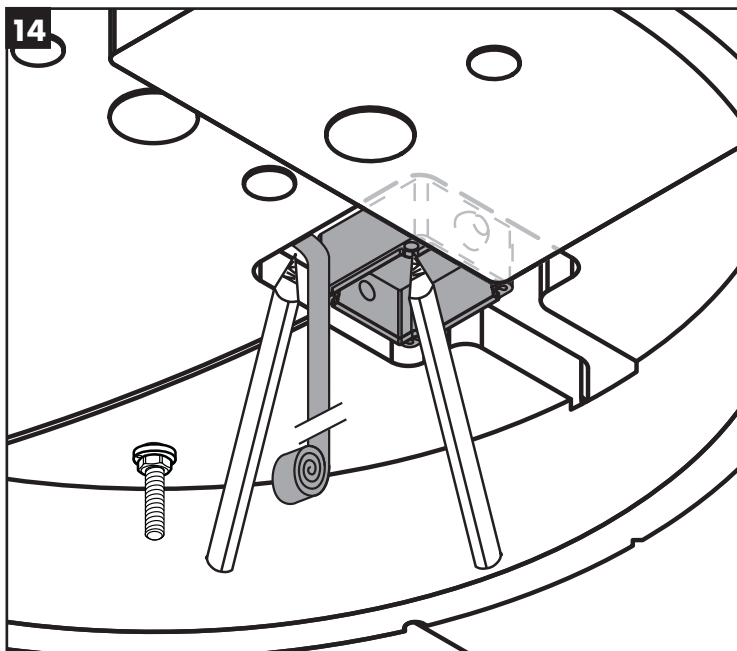

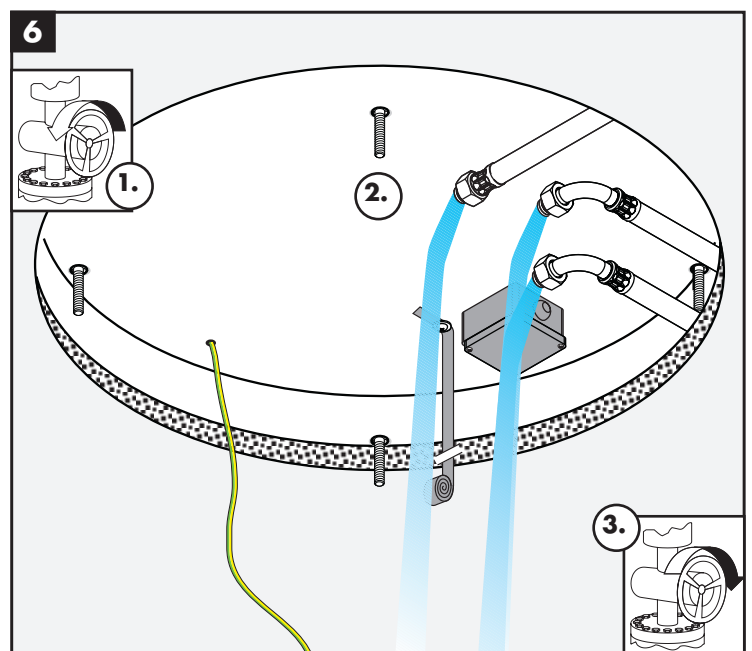
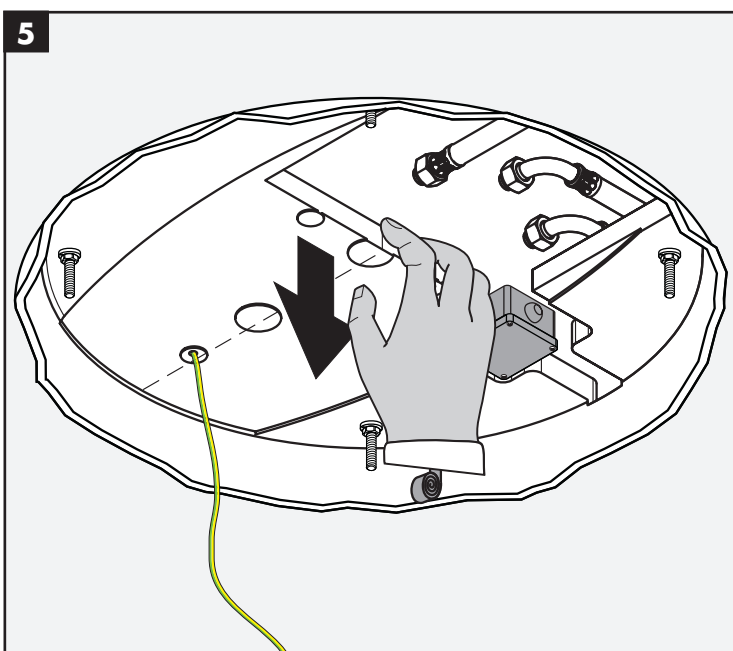
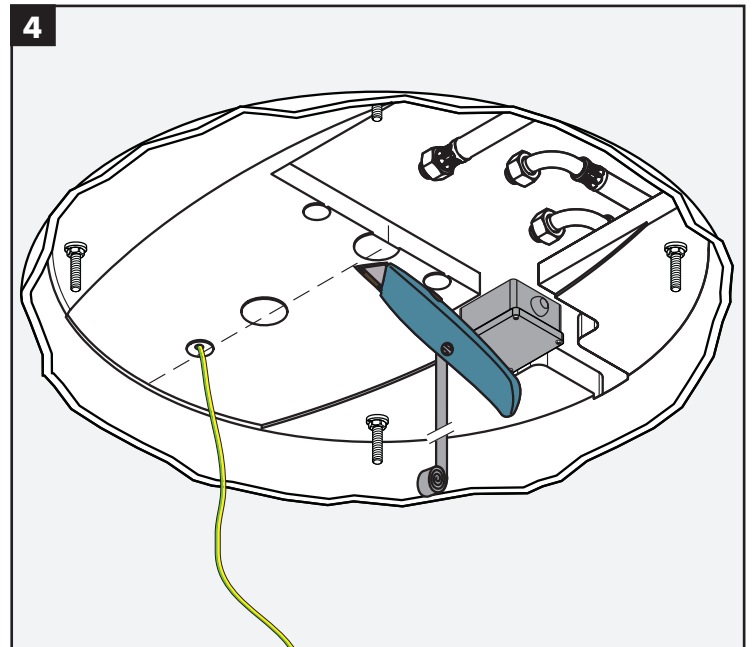
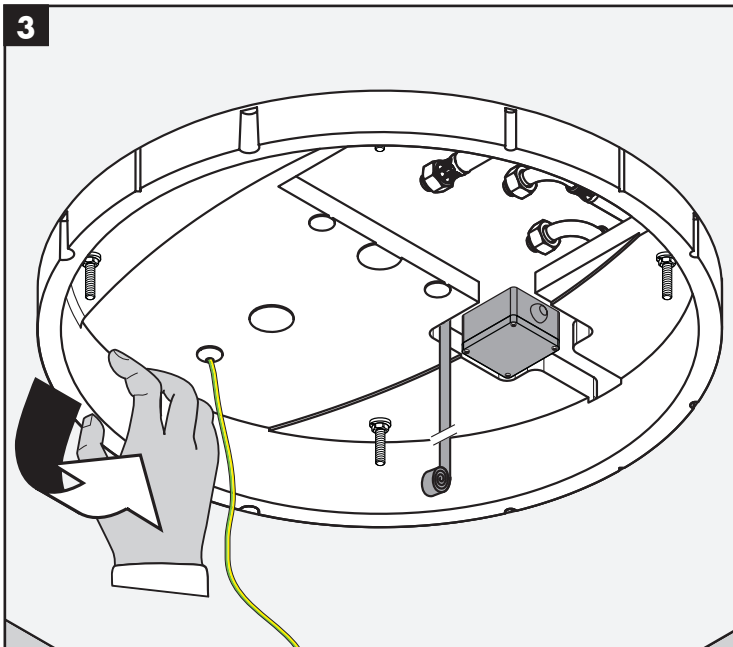
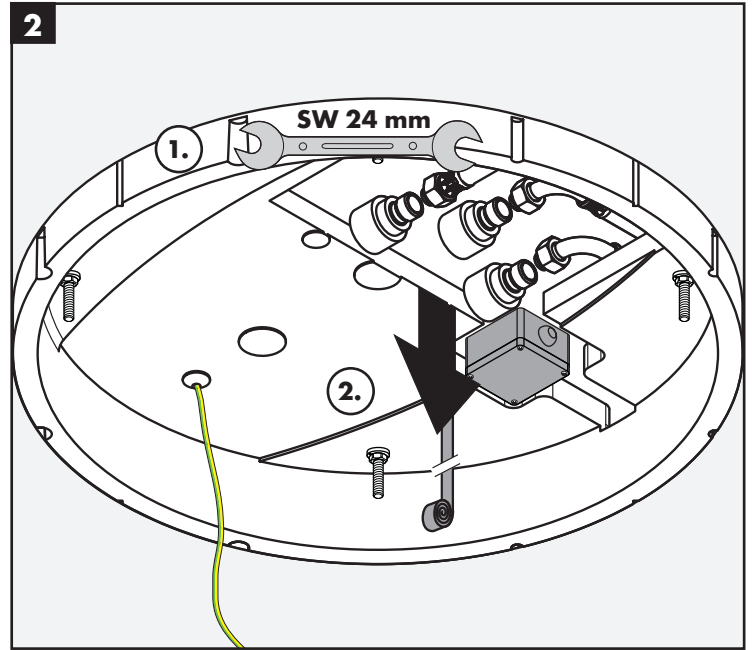
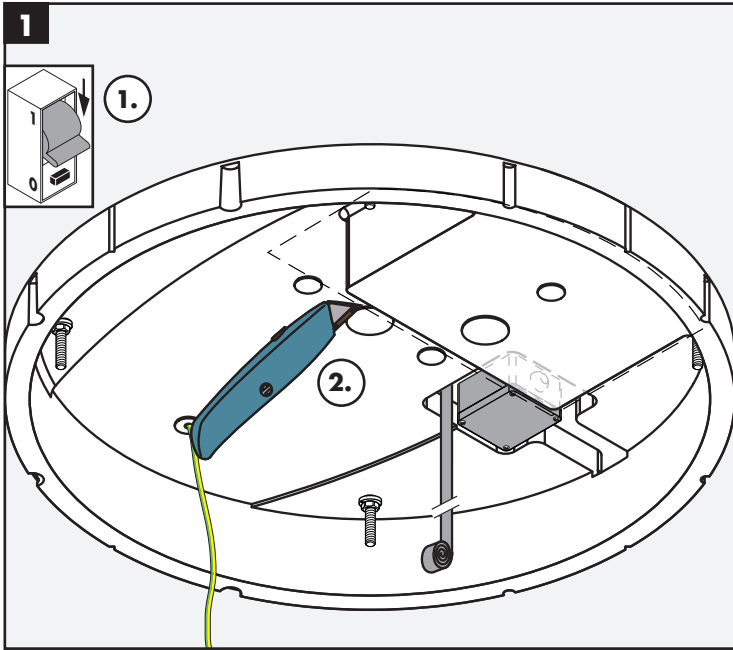
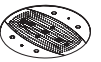

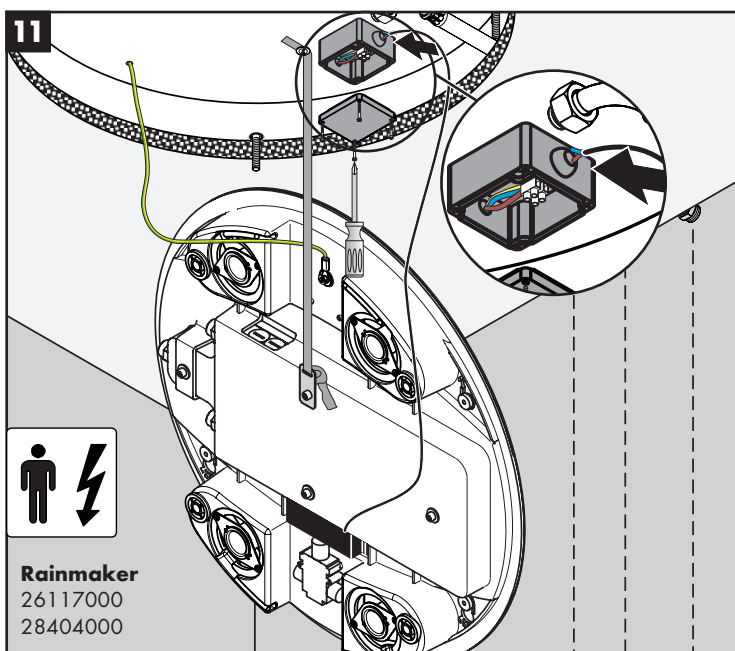
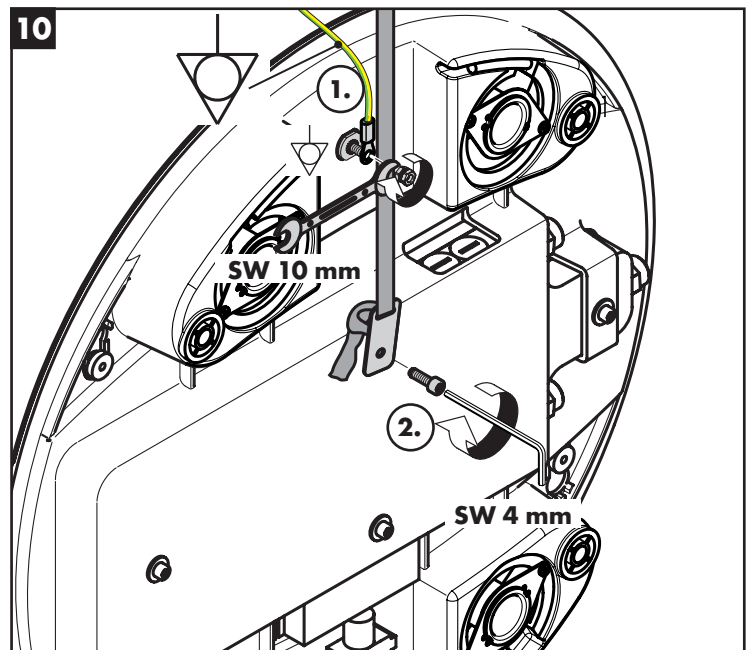
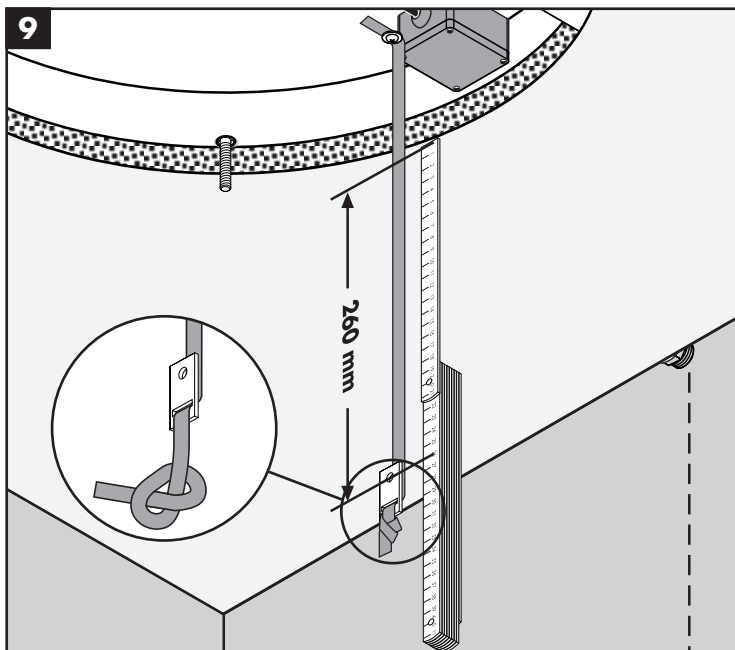
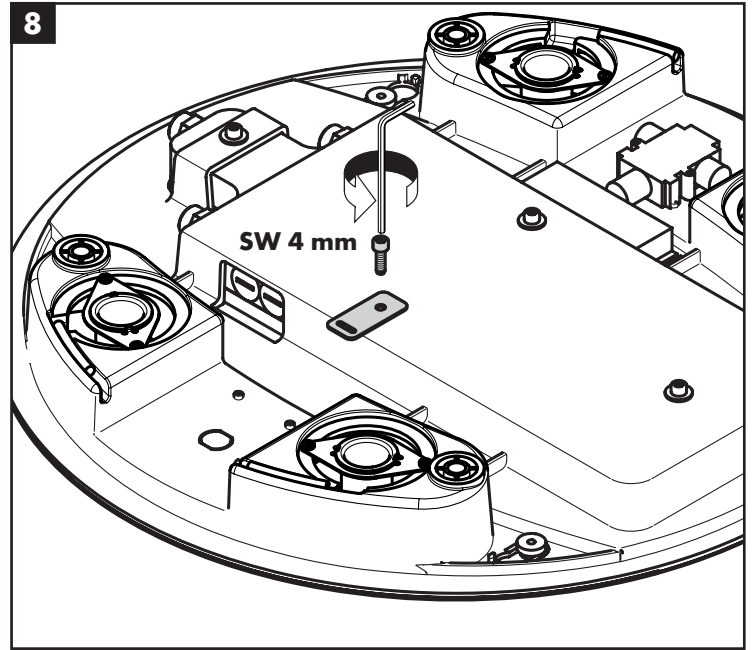
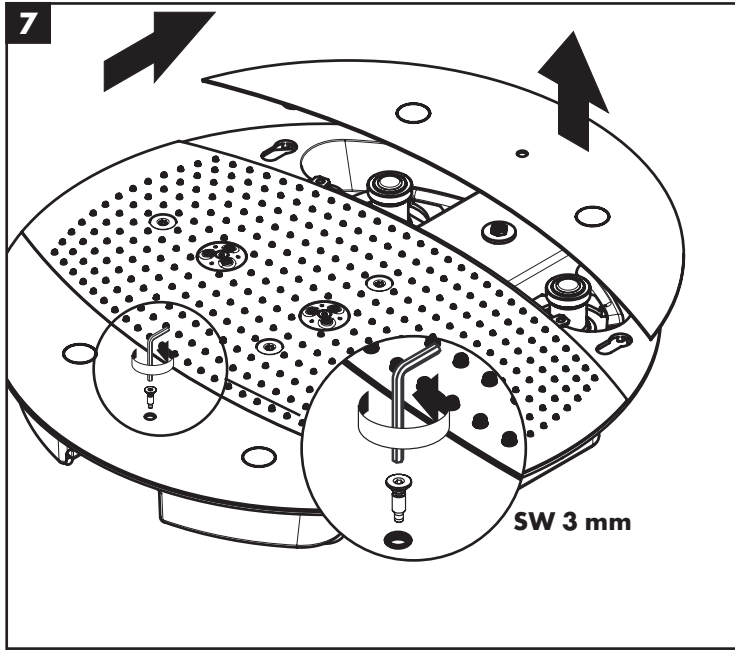
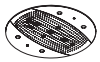

Rainmaker  
26117000  
28404000

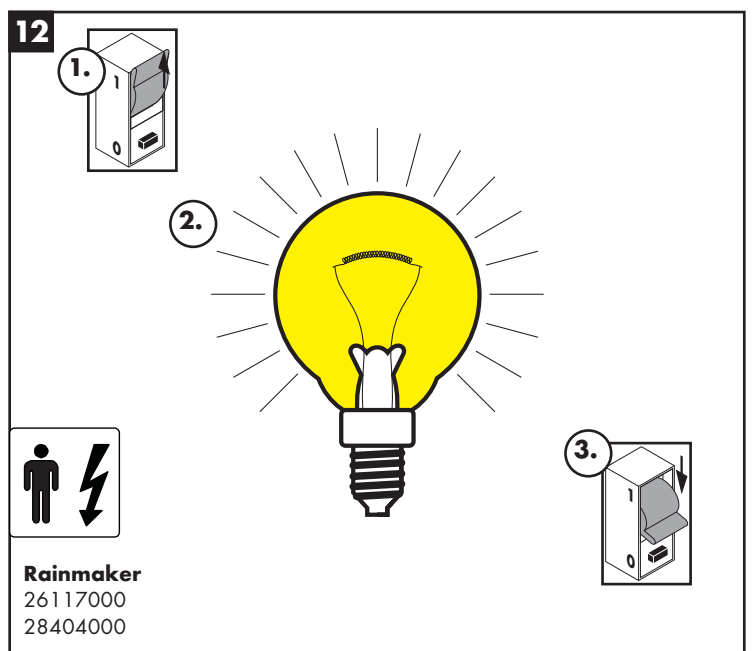

Rainmaker  
26117000  
28404000



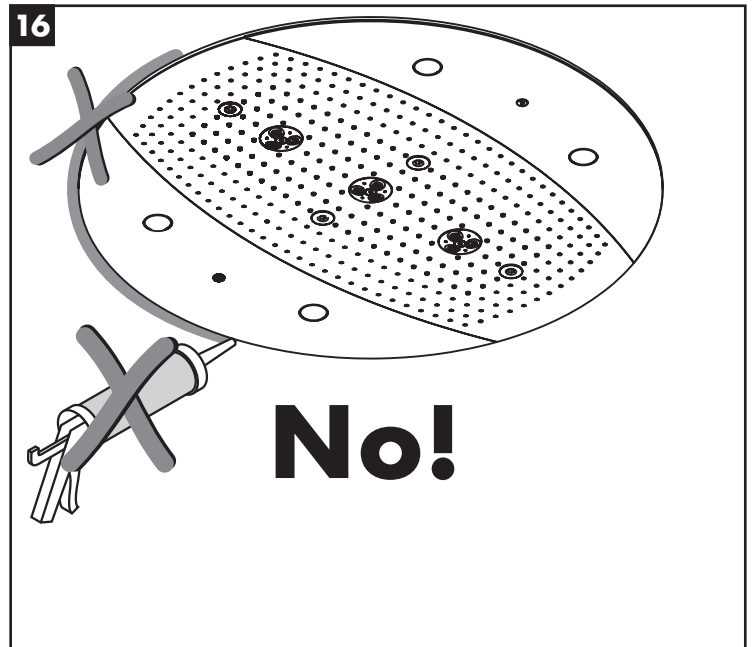
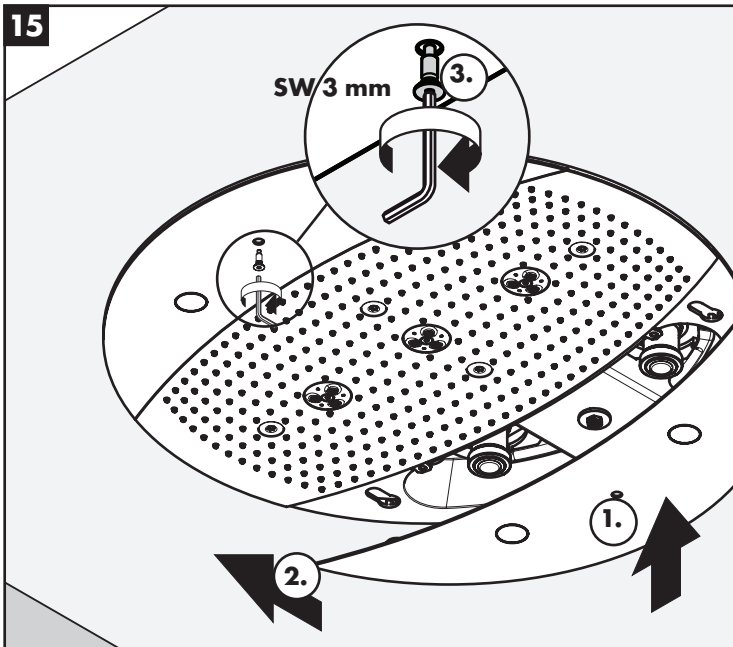
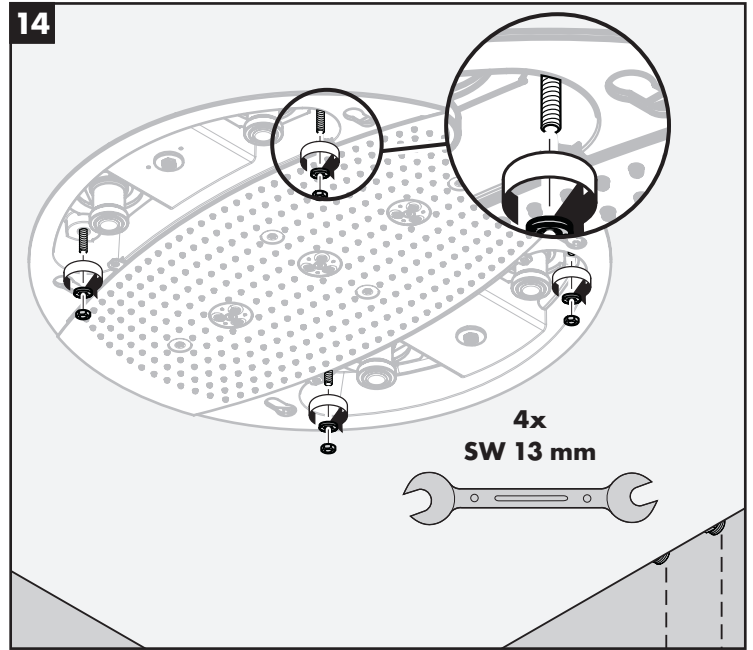
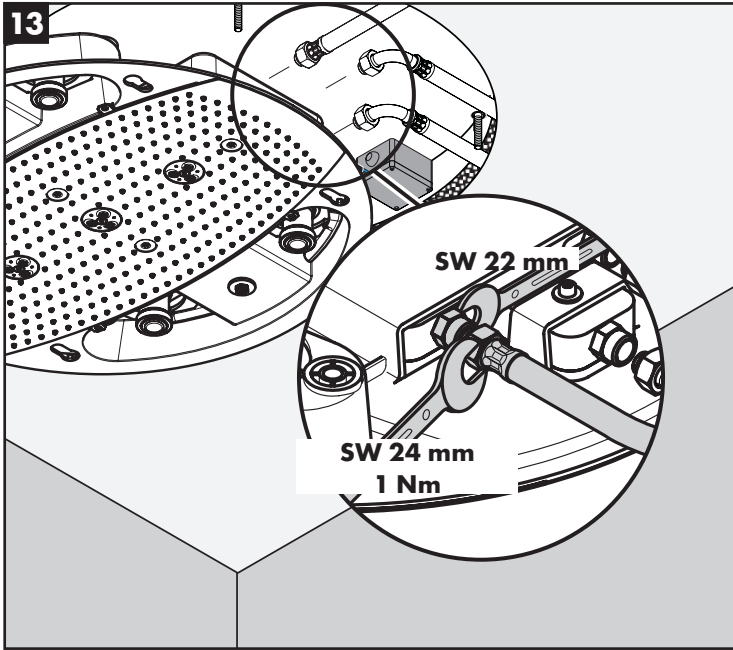
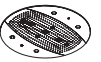

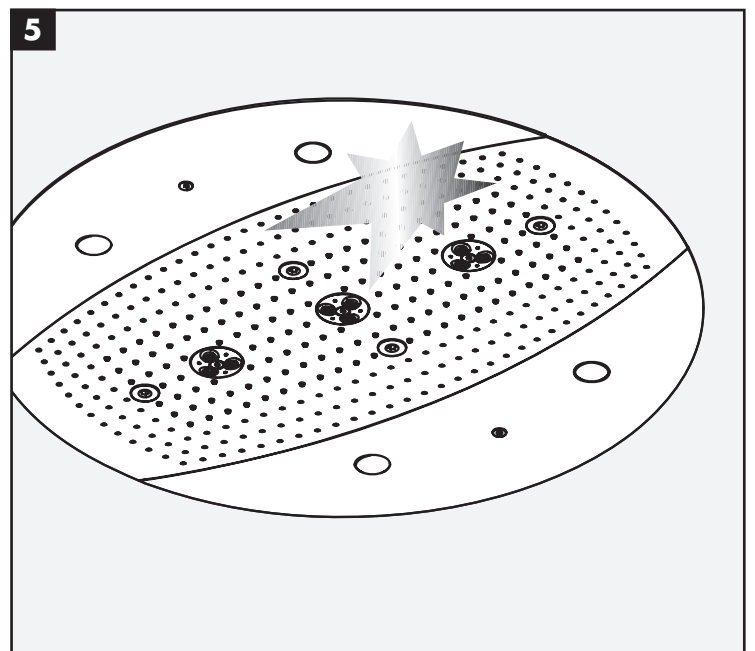
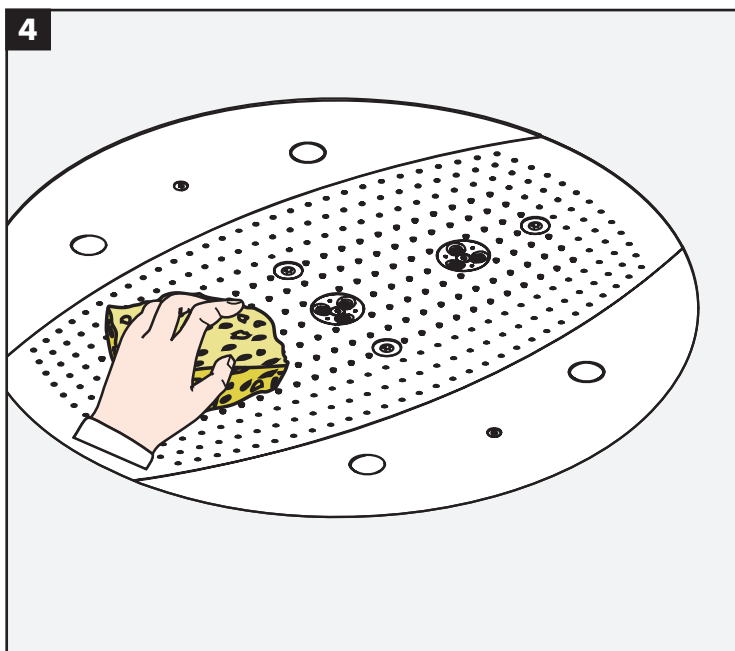
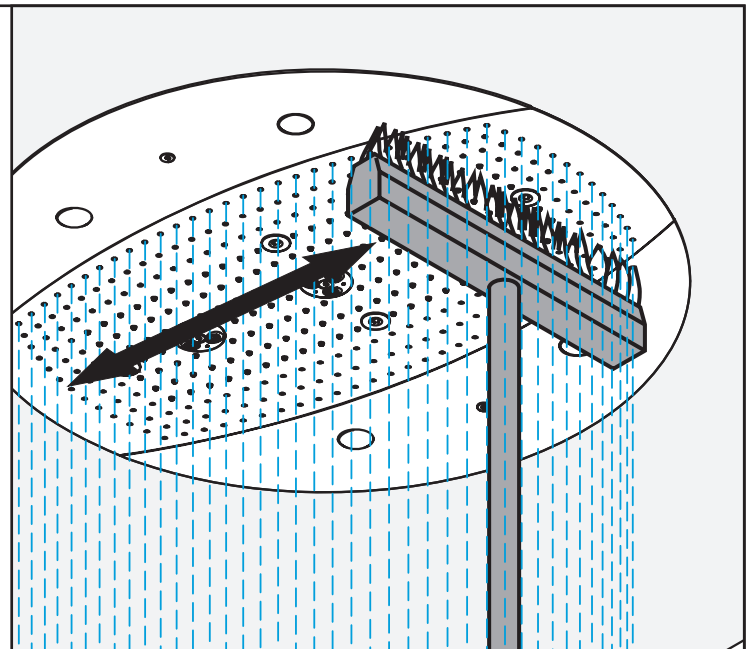
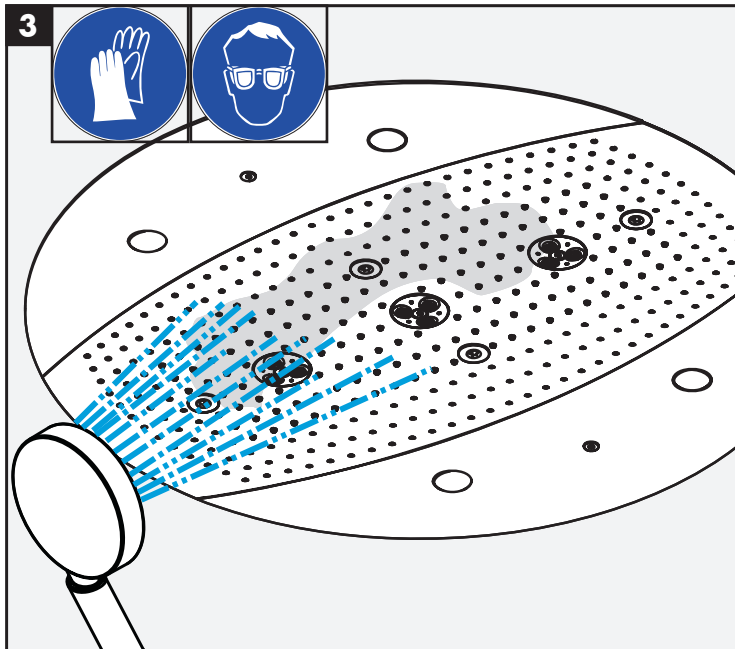
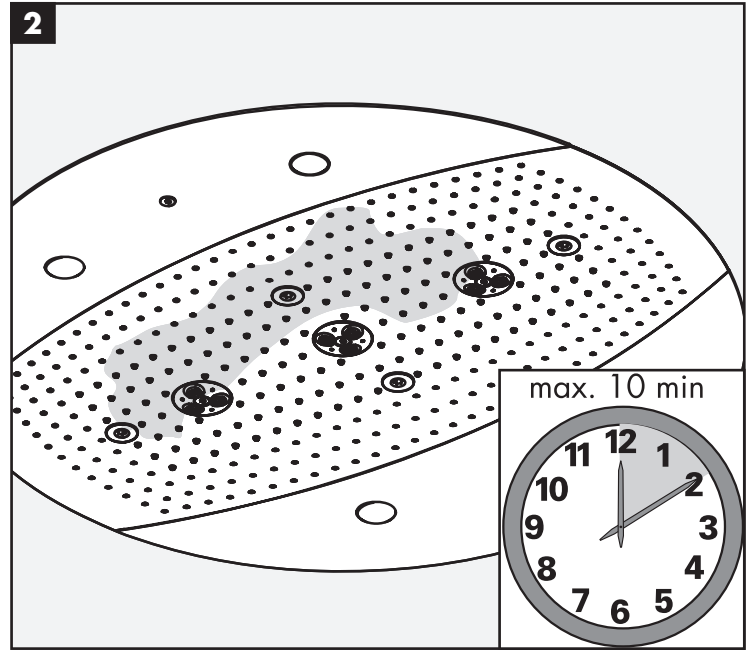
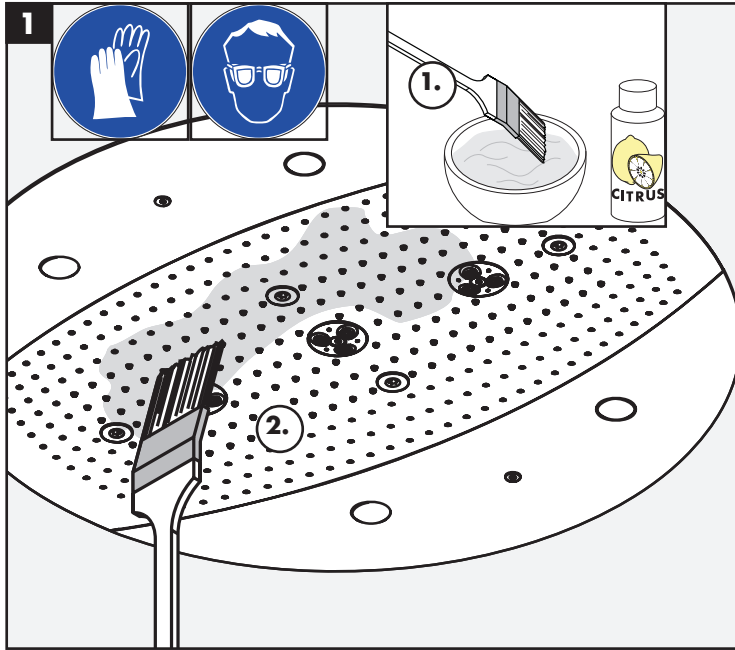
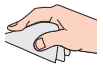

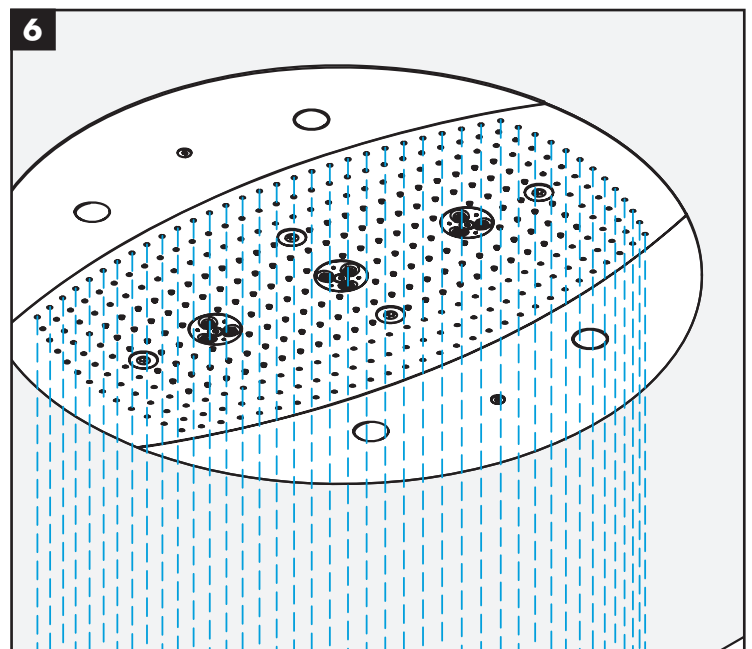
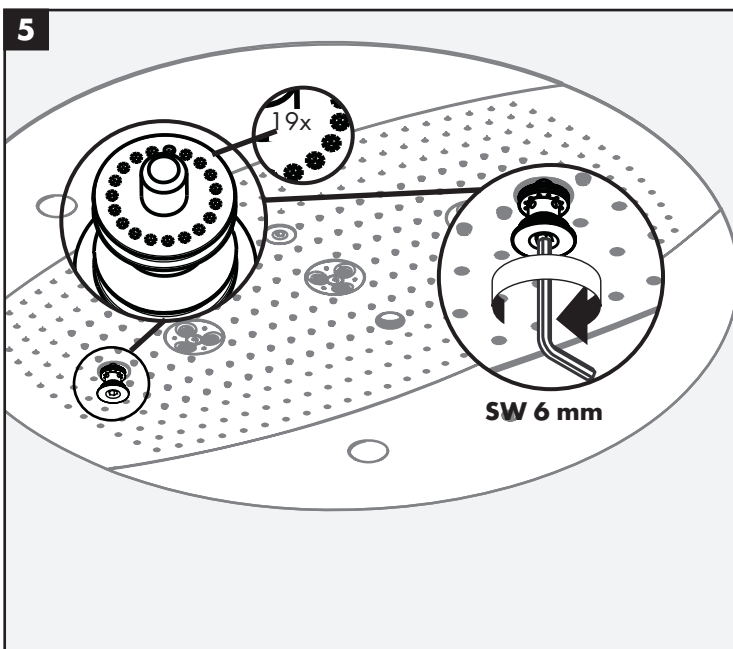
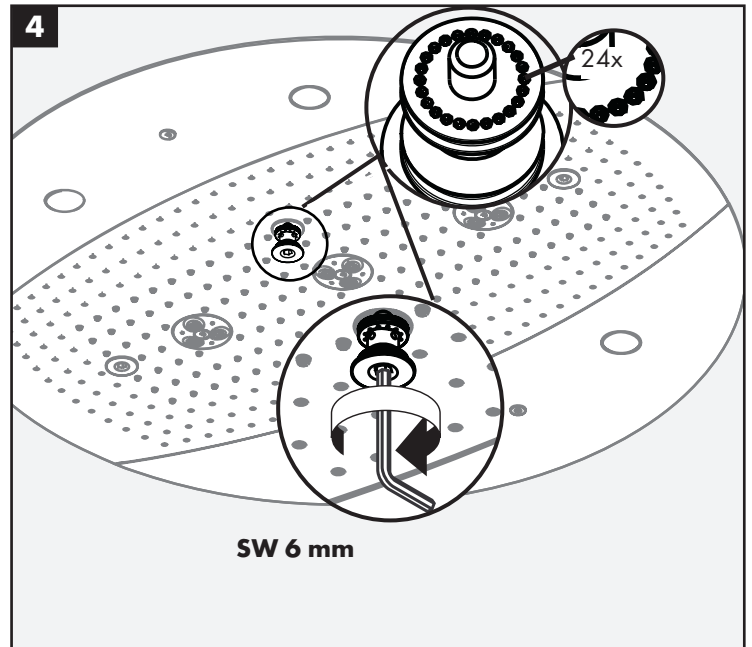
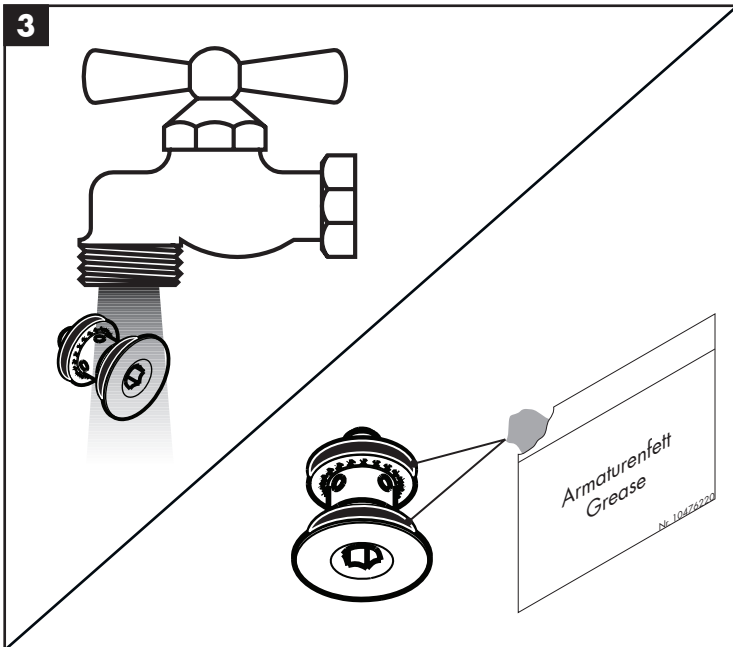
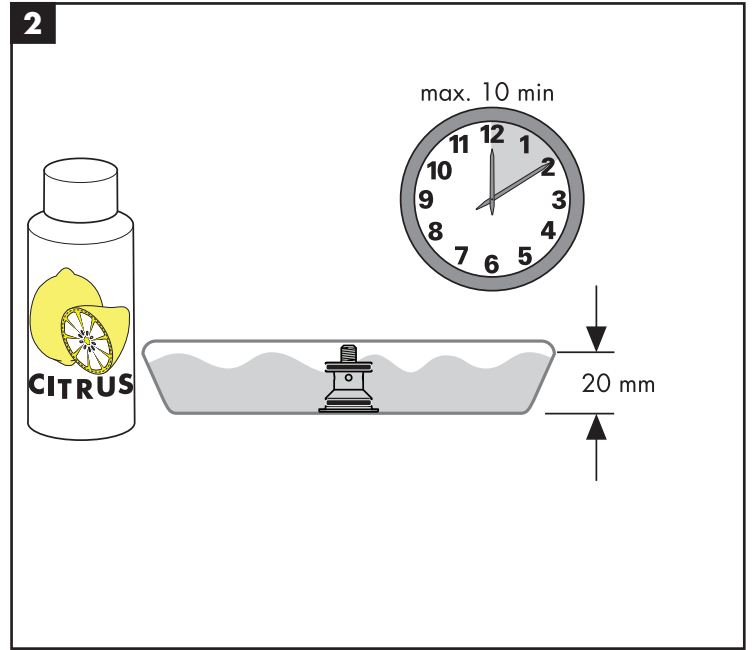
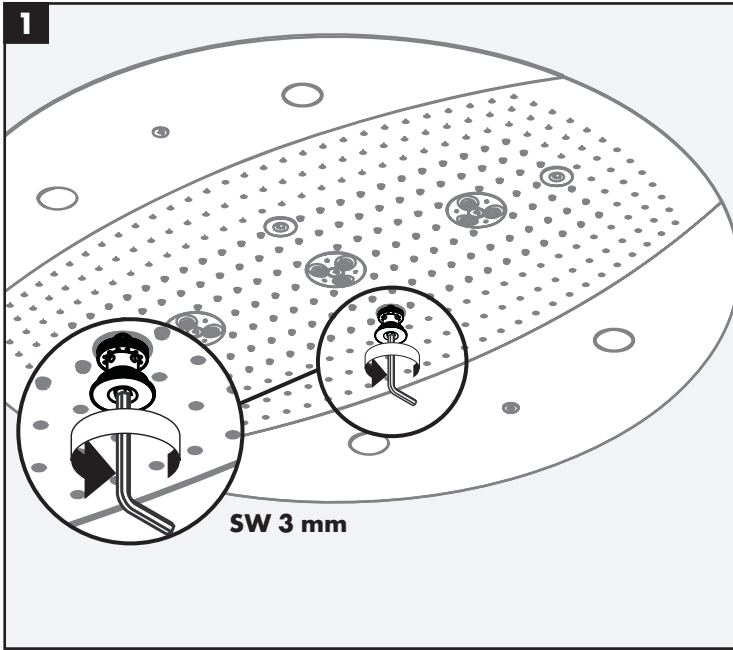

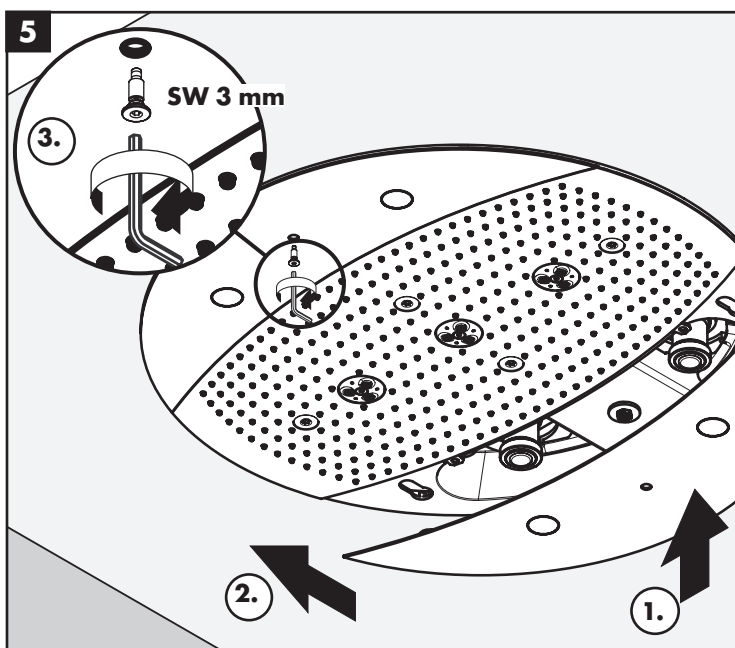
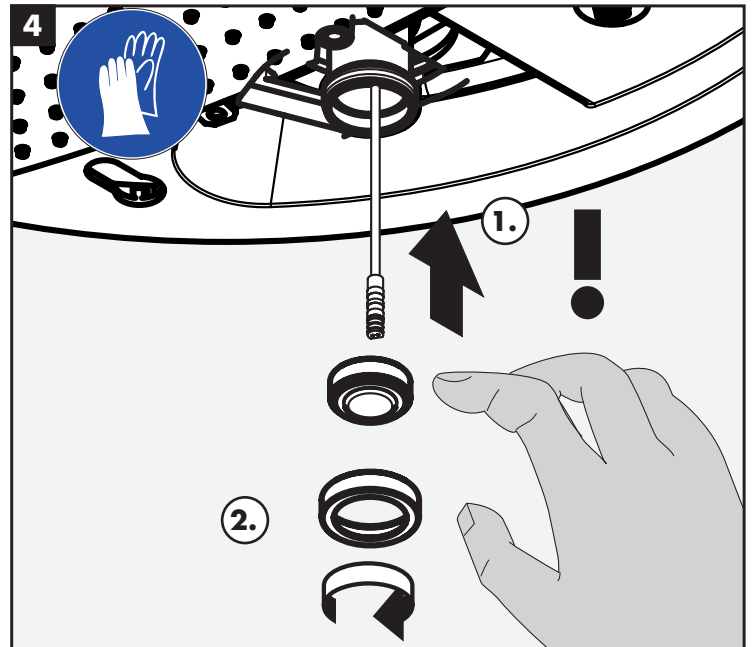
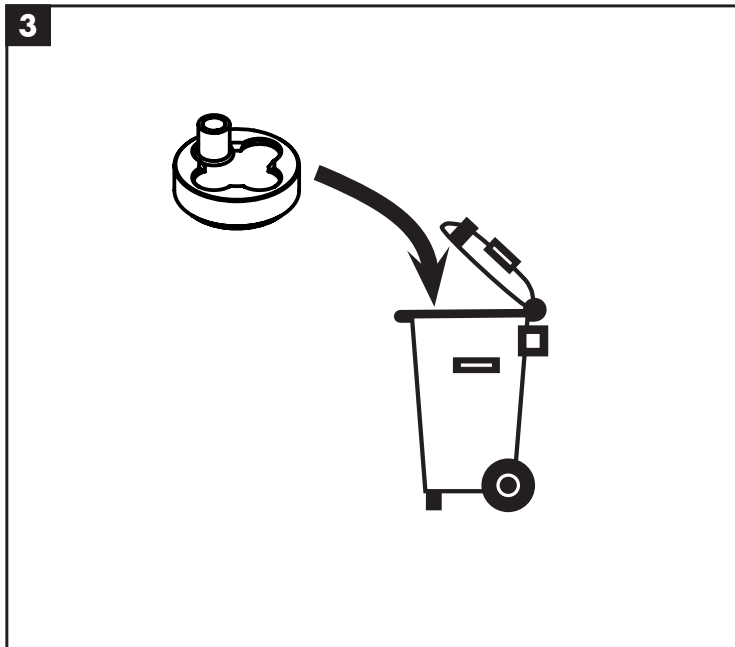
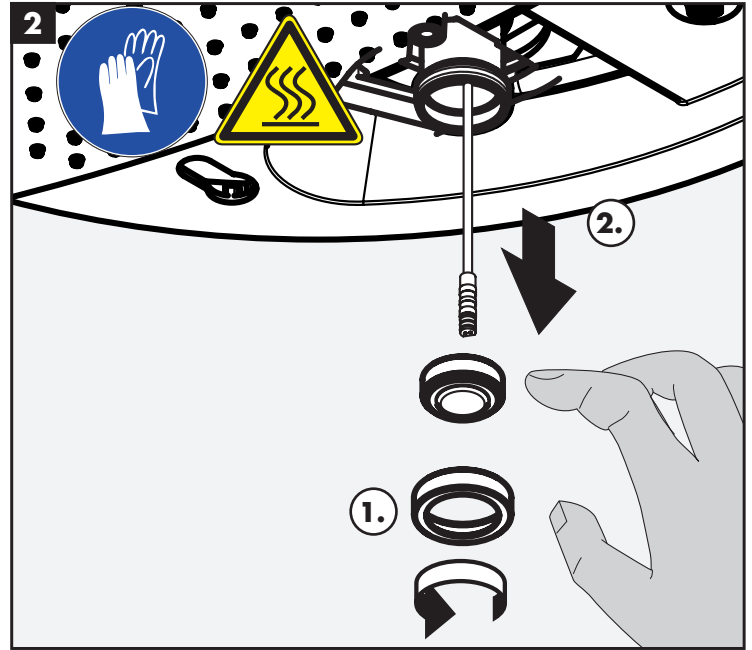
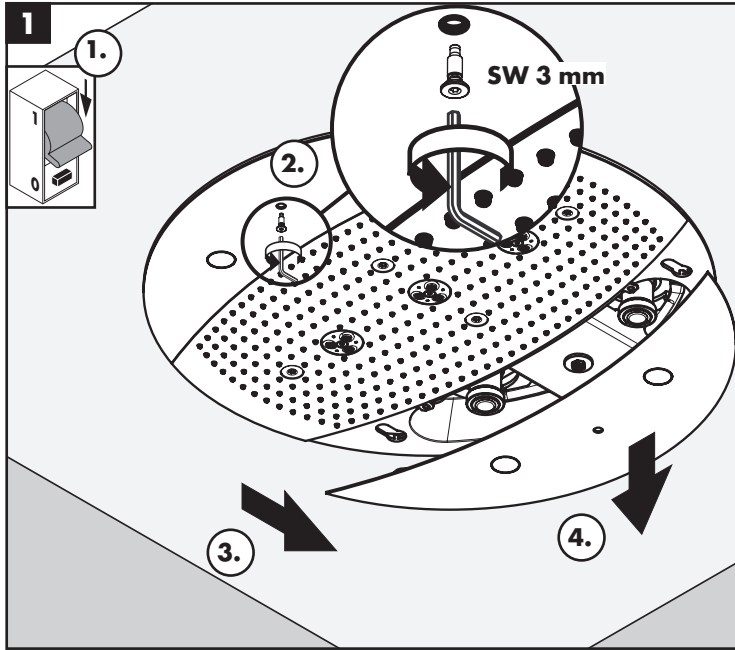

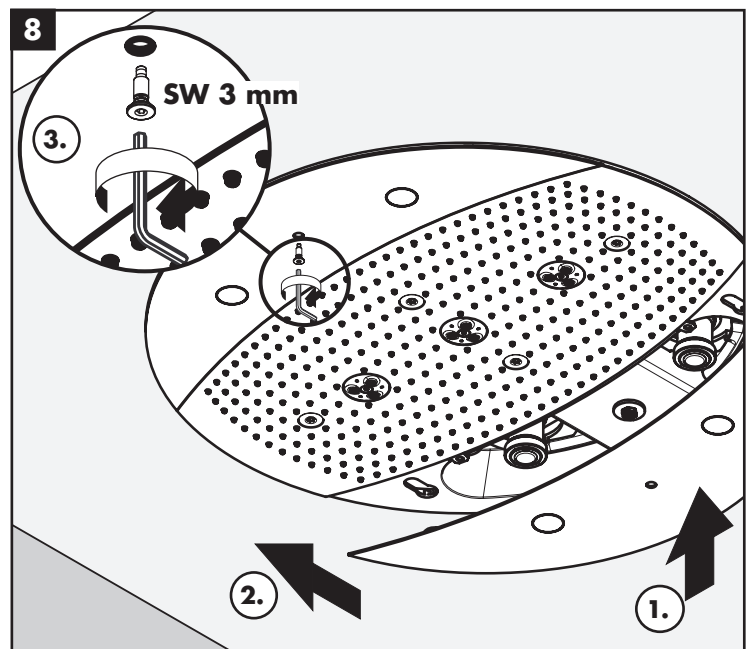
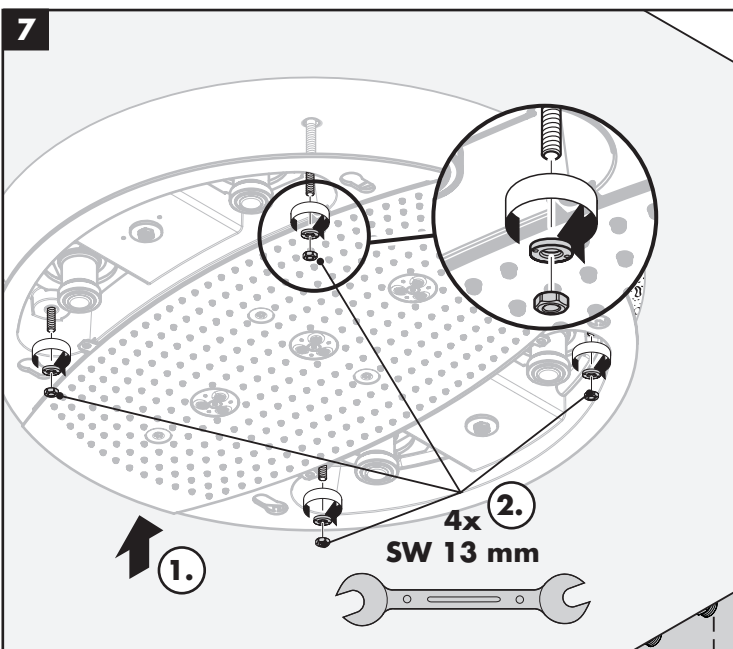
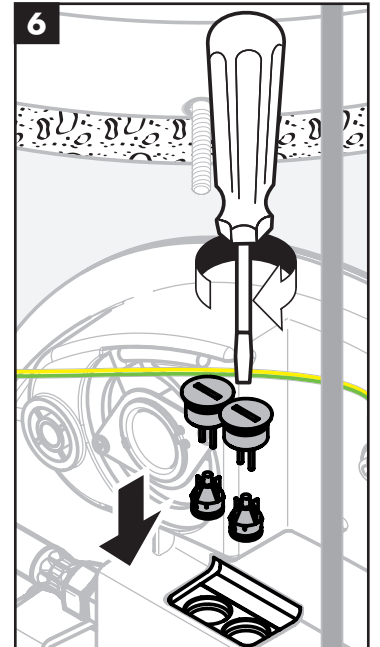
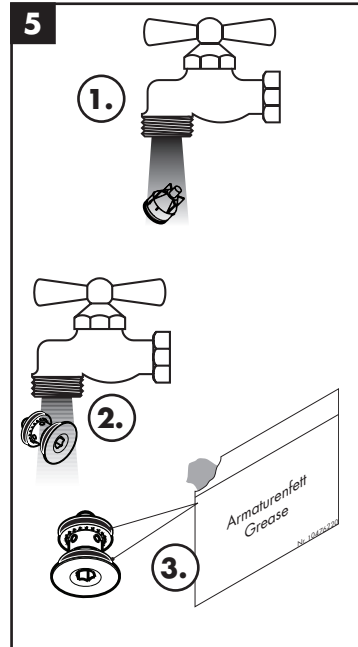
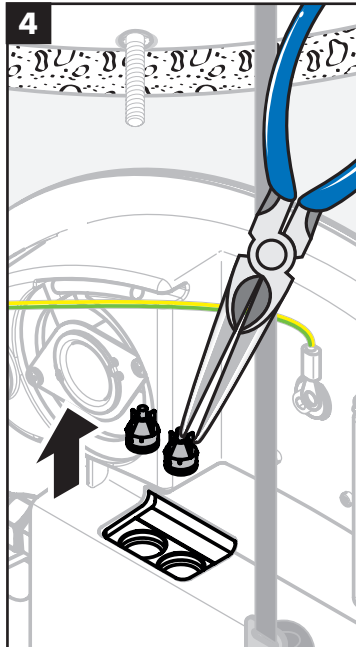
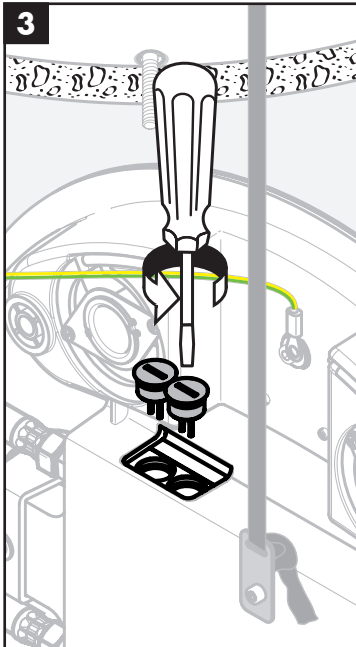
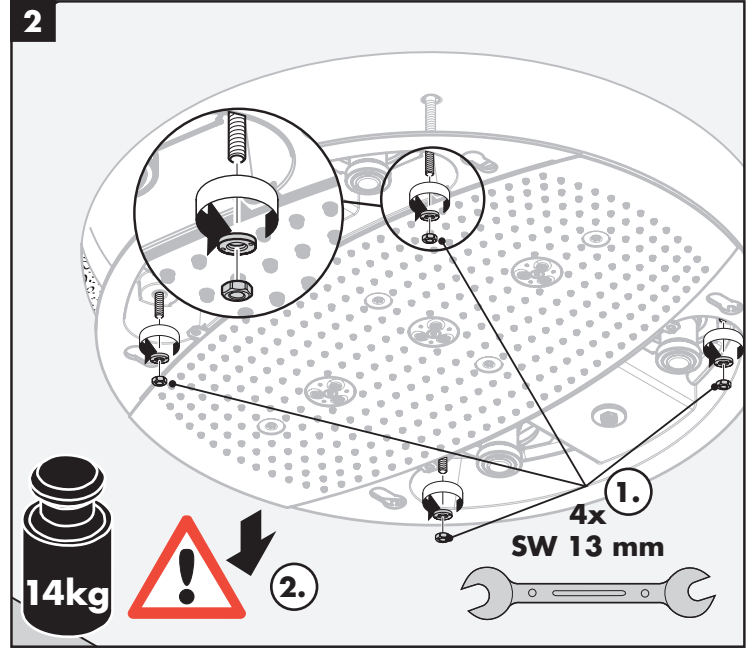
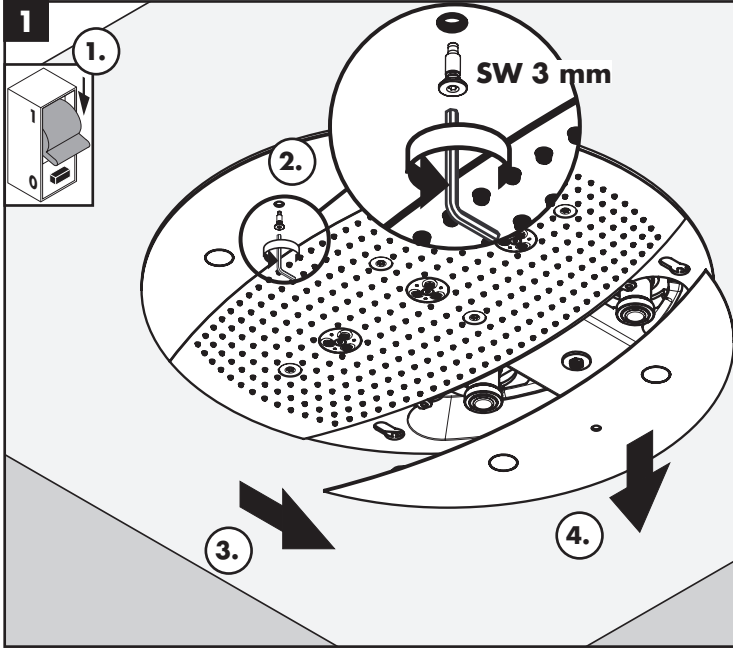



**P-IX**

**DVGW**

**SVGW**

**ACS**

**WRAS**

**ETA**



**26115000**

X

**26117000**

X

**28403000**

X

**28404000**

X

**28412180**

X



**hansgrohe**  
26117000, 28404000

 Diese Leuchte ist geeignet für Leuchtmittel der



Diese Leuchte wird verkauft mit einem Leuchtmittel der Energieklasse: 



**874/2012** 

- FR** Ce luminaire est compatible avec des ampoules des classes énergétiques: A+  
Le luminaire est vendu avec une ampoule de la classe énergétique: A+
- EN** This light fitting is compatible with bulbs from energy classes: A+  
The light fitting is sold with a bulb from energy class: A+
- IT** Questo dispositivo è compatibile con lampadine di classi energetiche: A+  
Il dispositivo è venduto con una lampadina di classe energetica: A+
- ES** Esta luminaria es compatible con bombillas de las clases energéticas: A+  
Esta luminaria se vende con una bombilla de la clase energética: A+
- NL** In deze armatuur passen lampen met energieklassen: A+  
De armatuur wordt verkocht met een lamp met energieklassen: A+
- DK** I denne lampe kan anvendes pærer i energiklasse: A+  
Denne lampe sælges med en pære i energiklasse: A+
- PT** Candeeiro compatível com lâmpadas das classes energéticas: A+  
Inclui uma lâmpada da classe energética: A+
- PL** Oprawa jest przystosowana do żarówek o klasach energetycznych: A+  
Oprawę sprzedaje się z żarówką o klasie energetycznej: A+
- CS** Toto svítidlo je kompatibilní se žárovkami energetických tříd: A+  
Toto svítidlo se prodává se žárovkou energetické třídy: A+
- SK** Toto svetidlo je kompatibilné so žiarovkami energetických tried: A+  
Toto svetidlo sa predáva so žiarovkou energetickej triedy: A+
- HU** A lámpatest a következő energiaosztályú égőekkel működik: A+  
A lámpatesttel együtt eladott égő energiaosztálya: A+

- FI** Valaisimessa voidaan käyttää seuraaviin energialuokkiin kuuluvia lampuja: A+  
Valaisimen mukana toimitettavan lampun energialuokka: A+
- SV** I denna ljusarmatur kan lampor av följande energiklasser användas: A+  
Denna ljusarmatur säljs med en lampa i energiklass: A+
- LT** Šviestuvą galima naudoti su šiuo energijos klasių lemputėmis: A+  
Šviestuvą parduodamas su lempute, kurios energijos klasė yra: A+
- HR** Ovo rasvjetno tijelo kompatibilno je sa žaruljama ovog energetskog razreda: A+  
Rasvjetno tijelo se prodaje sa žaruljama ovog energetskog razreda: A+
- RO** Acest corp de iluminat este compatibil cu becurile din clasele energetice: A+  
Acest corp de iluminat este vândut cu un bec din clasa energetică: A+
- EL** Το Φωτιστικό αυτό είναι συμβατό με λαμπτήρες ενεργειακής τάξης: A+  
Το Φωτιστικό αυτό πωλείται με λαμπτήρα ενεργειακής τάξης: A+
- SL** Ta svetilka je združljiva s sijalkami naslednjih energijskih razredov: A+  
Ta svetilka se prodaja s sijalko energijskega razreda: A+
- ET** Sellesse valgustisse saab panna järgmiste energiklasside lampe: A+  
Seda valgustit müüakse koos lambiga, mille energiklass on: A+
- LV** Šis gaismeklis ir saderīgs ar šādu energoefektivitātes klašu spuldzēm: A+  
Šo gaismekli pārdod ar šādas energoefektivitātes klases spuldzi: A+
- BG** това осветително тяло е съвместимо с крушките от енергийни класове: A+  
това осветително тяло се продава с крушка от енергиен клас: A+